

**PRICE LIST 2023**  
**FURNITURE**

EURO, EXCL. VAT / 01.2023

**FRITZ HANSEN**

# CONTENT

- 03 • General terms and conditions
- 04 • General terms and conditions

## CHAIRS

- 05 • Ant™
- 06 • Series 7™
- 07 • Series 7™ / Children's chair / Junior chair
- 08 • Series 7™
- 09 • Series 7™ Children's Chair / Junior
- 10 • Dot™ / High Dot™
- 11 • Grand Prix™
- 12 • Grand Prix™
- 13 • Lily™
- 14 • Drop™
- 15 • Little Giraffe™
- 16 • Oxford™
- 17 • Oxford™
- 18 • N01™
- 19 • N02™ Recycle
- 20 • NAP™
- 21 • Vico Duo™
- 22 • Vico Duo™
- 23 • China Chair™

## LOUNGE

- 24 • Series 3300™
- 25 • Egg™
- 26 • Swan™
- 27 • Oksen™
- 28 • Pot™
- 29 • Ro™
- 30 • Fri™
- 31 • VIA57™
- 32 • Fred™
- 33 • Let™

## SOFAS

- 34 • Series 3300™
- 35 • Swan Sofa™
- 36 • Lissoni Sofa™
- 37 • Alphabet™ Sofa Series
- 38 • Alphabet™ Sofa Series
- 39 • Favn™
- 40 • Lune™
- 41 • Lune™
- 42 • Ro™ Sofa
- 43 • Plenum™

## TABLES

- 44 • Superellipse™
- 45 • Superellipse™
- 46 • Supercircular™
- 47 • Circular
- 48 • Rectangular
- 49 • FH3605™
- 50 • AJ Trolley
- 51 • Stub
- 52 • Essay™
- 53 • Essay™
- 54 • Analog™
- 55 • Join™
- 56 • Pluralis™
- 57 • Pluralis™
- 58 • Pluralis™
- 59 • Little Friend™
- 60 • Planner™ Table Series
- 61 • Egg™ Table

## SHELVING

- 62 • Planner™ Shelving

## OTHER

- 63 • Coat Tree™ / Coat Tree™ Wall

- 64 • SPARE PARTS

- 65 • SPARE PARTS

- 66 • SURFACE SELECTION

# GENERAL TERMS AND CONDITIONS

## CURRENCY & EFFECTIVE DATE

This price list is valid from 14 January 2023 and cancels all prior price lists.

Reservation is made for any errors and omissions. Furthermore, below general terms and conditions shall apply to all contracts under which Fritz Hansen A/S (Fritz Hansen) is the supplier/sub-supplier.

## ORDERING

Orders must be placed through Fritz Hansen's web-based order system called the Partner Portal ([www.fritzhansen.com](http://www.fritzhansen.com) - professional). Orders are not binding until the customer has received a written order confirmation from Fritz Hansen.

Price lists state the recommended retail price (RRP) or prices excl. VAT exclusive of freight and fees. All prices can be changed without notice. Changes to the collection such as discontinued products and/or items out of stock can occur even when stated differently in the price list. Updated information will be available on the partner portal only.

## ORDER CANCELLATION

Orders can be cancelled in accordance with the below rules:

	ORDERS CANCELLED 0-3 DAYS AFTER ORDER CONFIRMATION HAS BEEN SENT	ORDERS CANCELLED 3-14 DAYS AFTER ORDER CONFIRMATION HAS BEEN SENT
STANDARD PRODUCTS	FEE: NONE	FEE: 5% OF NET PRICE EXCL. VAT.
SPECIALS OR MODIFIED PRODUCTS	FEE: FULL PRICE	

Change and cancellation of order after 14 days from receipt of the order confirmation is not possible.

## DELIVERY

The following freight rates apply:

RATE	PER ORDER
EU+UK+NO+CH+US*	DKK 200 / € 55 / £ 50 / SEK 600 / NOK 550 / USD 55 EXCL. VAT.
REST OF THE WORLD	TO BE PICKED UP AT FRITZ HANSEN WAREHOUSES

For markets EU+UK+NO+CH+US free freight offered according to the following rates: Free shipping from DKK 3.000 / € 400 / £ 350 / SEK 4.500 / NOK 4.000 / USD 500 total order value excl. VAT.

\* For deliveries to outer areas such as islands in Portugal and Spain as well as Svalbard in Norway and others, a surcharge of DKK 420 / € 56 / £ 42 / NOK 580 per parcel will apply.

### Standard delivery terms:

- Denmark: DDP delivery address (INCO-Terms 2020)
- Countries within the EU: DDP delivery address (INCO-Terms 2020)
- European countries outside the EU: DAP delivery address (INCO-Terms 2020)
- USA & Canada: DDP delivery address (INCO-Terms 2020)
- Japan: DDP delivery address (INCO-Terms 2020)
- South Korea: DAT Seoul Airport (INCO-Terms 2020)
- Middle East, Asia, South and Central America, Australia: FCA Fritz Hansen warehouses in Denmark and Poland (INCO-Terms 2020)

For FCA: The goods must be picked up at the Fritz Hansen warehouses no later than 30 calendar days after the confirmed shipping date of the consolidated order. Address(es) for pickup will be specified on the commercial invoice. If the goods are not picked up, Fritz Hansen will charge the customer DKK 24 / € 3 / USD 4 per day per pallet.

If the partner so desires, Fritz Hansen can deliver at the end user's address against an additional fee.

## CLAIMS

The physical product must be inspected upon delivery. Damage incurred in transit as well as any defects and deficiencies on the product incurred as a result of transportation must be recorded on the POD upon delivery. Fritz Hansen must be notified in writing of any claims about product defects and deficiencies within 48 hours of delivery. If the claims are made in due time and with the acceptance of Fritz Hansen, the customer is entitled to demand a replacement delivery or to have the defect remedied. The customer cannot demand a reduction or a compensation. Claims/replacements can only be made to the customer's address if delivery has not been made directly to the end user.

## TERMS OF PAYMENT

Terms of payment are 30 days net cash from invoice date. Invoices are issued and dated when the goods are dispatched. In case of late payment, interest will be charged at a rate of 1.5 % for every month or part thereof as from the due date. Interest invoices are payable net cash within eight days. Fritz Hansen can decide that the customer shall pay in advance, if the customer's balance is or has previously been due, or if the order amount exceeds the credit limit approved by Fritz Hansen.

## OBSERVATION OF TITLE

Title to the goods shall not pass to the customer until Fritz Hansen (or any third party to whom Fritz Hansen has assigned its rights to the purchase price) has received the full purchase price and been reimbursed any expenses incurred.

## WARRANTY

Fritz Hansen provides a standard five-year warranty on standard products within the collections Furniture, Outdoor and Skagerak Indoor against defects in materials and workmanship. For the Furniture collection an extended warranty of up to 10 years is provided on selected products, provided they have been registered online on [www.fritzhansen.com/my-fh](http://www.fritzhansen.com/my-fh) (see table on the following page for details).

For the Poul Kjærholm collection the standard warranty is 20 years except for PK0 A™ and PK60™ which is 10 years and wicker which is 2 years.

For the Lighting, Accessories and Skagerak Accessories collection the standard warranty is 2 years. Specific for the Lighting category: Transformers, ballasts, light sources, and other electronic devices are subject to the warranty terms of the manufacturer in question. Fritz Hansen does not cover costs related to installation and dismantling, replacement of ballasts/transformers and other similar costs related to electricians and the like.

The warranty on all collections does not extend to ordinary wear, tear or damage to upholstery. On any material, fabric, or leather which is not listed in our price lists configured on a specific product, the standard warranty is 2 years. The warranty is void upon subsequent changes to the product.

Additional warranty conditions can be found on [www.fritzhansen.com](http://www.fritzhansen.com).

## LIMITATION OF LIABILITY

Fritz Hansen will assume no liability for any loss as a result of delays, defects or any other breach of contract, unless such loss was caused by gross negligence on the part of Fritz Hansen. Fritz Hansen will assume no liability for any indirect loss, including loss of profits, operating loss, goodwill, loss of customers, running costs or any other consequential economic loss.

**CHOICE OF LAW AND JURISDICTION**

Disputes between Fritz Hansen and its customers shall be subject to Danish law, except for the international civil law rules of Danish law, and shall be settled by Fritz Hansen’s home court.

**MEASUREMENTS**

The stated measurements act only as a guideline. The measurements can vary, and size difference on a product can occur.

**FORCE MAJURE**

Fritz Hansen is without liability for non-performance of Fritz Hansen’s obligations in respect to any orders received, if such non-performance is due to circumstances out of Fritz Hansen’s reasonable control, which prevent the fulfilment of the purchase agreement or makes the fulfilment unreasonably burdensome. As examples of such circumstances the following can be mentioned: Industrial dispute and other circumstances which are beyond the control of the parties, such as fire, war, mobilization or calling in for military service of similar extent, requisition, seizure, exchange controls, riots or disturbances, shortage of means of transportation, ordinary scarcity of goods, restrictions of motive power and defects in or late performance from sub-suppliers due to any of the aforementioned circumstances.

The above circumstances only lead to exemption from liability if their influence on the fulfilment of the purchase agreement could not be anticipated at the conclusion of the agreement. Fritz Hansen must without undue delay notify the customer in writing if any such circumstances, occurrence and cessation, if Fritz Hansen wishes to invoke any grounds of exemption from liability.

Regardless of what follows from these general conditions of sales and delivery, any party is entitled to terminate the purchase agreement by notifying the other party in writing, if the fulfilment of the agreement is prevented for more than 6 months due to one of the above circumstances.

Unless mandatory rules preclude this, Fritz Hansen is in no case liable to the customer for operating losses, lost earnings, or other financial consequential damages under these general conditions for sale and delivery.

**PRIVACY POLICY**

At Fritz Hansen, confidentiality and data protection is a high priority. Guidelines for processing of personal data and description of the customer’s and end users’ rights according to applicable data protection law is governed by Fritz Hansen’s privacy policy available on Fritz Hansen’s website.

# WARRANTY OVERVIEW

Price list collections	Furniture collection						Poul Kjærholm collection		Outdoor collection	Skagerak indoor collection	Lighting collection	Accessories collection	Skagerak Accessories collection						
	Fabric	Leather (1)	Leather (2)	Bases (3)	Bases (4)	Movable parts (5)	Cushions	Shells	Tabletops (6)	Tabletops	China Chair™	Wicker	PKO A™ & PK60™	Poul Kjærholm collection	Outdoor	Skagerak indoor	Lighting	Accessories	Skagerak collection
2 years												x					x	x	x
5 years	x	x		x		x	x		x						x	x			
10 years			x*		x*			x*	x*				x**						
20 years										x**			x**						

- 1. Leather: Soft and Essential
- 2. Leather: Aura, Rustik, Natural, Grace and Embrace
- 3. Bases: Lacquered and Wooden (chairs), Powder coated (chairs and tables)
- 4. Bases: Aluminium, Chrome and Wooden (tables)
- 5. Moveable parts: Automatic return, Tilt, Height-adjustable, Swivel, Castors and Extension mechanism
- 6. Tabletops: Lacquer under tabletop, Lacquer on edges and Surface on tabletop

\* Additional with registration on [www.fritzhansen.com/my-fh](http://www.fritzhansen.com/my-fh)  
 \*\* Standard without registration



The Ant™ comes in natural, coloured ash or lacquered veneer. All chairs are made of pressure moulded veneer and are stackable. The shell is also available in front upholstered versions in a wide range of textiles and leather types. The base comes with 3 or 4 legs made of chromed or powder-coated tubular steel.

MODEL	DESCRIPTION	COLOURED ASH	LACQUERED	NATURAL VENEER
3100	Chair, 3 legs, stackable (max 8 pcs), seat height 44 cm or 46 cm, chromed or powder coated tubular steel base	264	278	397
3101	Chair, 4 legs, stackable (max 12 pcs), seat height 44 cm or 46 cm, chromed or powder coated tubular steel base	264	278	397

COLOURED ASH AND LACQUERED - SEE THE SURFACE SELECTION

PALE ROSE (610/615), WILD ROSE (630/635), VENETIAN RED (670/675), PARADISE ORANGE (570/575), BURNT YELLOW (470/475), TRUE YELLOW (460/465), LIGHT BEIGE (130/135), DEEP CLAY (140/145), OLIVE GREEN (920/925), LAVENDER BLUE (810/815), DUSK BLUE (850/855), MIDNIGHT BLUE (890/895), EVERGREEN (950/955), BLACK (190/195), NINE GREY (150/155), WHITE (100/105)

NATURAL VENEER VARIANTS - SEE THE SURFACE SELECTION

MAPLE (10), BEECH (20), ASH (30), CHERRY (40), OREGON PINE (50), ELM (60), OAK (70), WALNUT (80), DARK STAINED OAK (90), FULL DARK STAINED OAK (90)

BASE COLOURS

SILVER GREY (170), WARM GRAPHITE (180), BROWN BRONZE (390), BLACK (190), WHITE (100, ONLY WITH WHITE SHELL), NINE GREY (150), CHROME

FRONT UPHOLSTERED - COLOURED ASH

MODEL	DESCRIPTION	CHRISTIANSHAVN	CATEGORY 1	CATEGORY 2	CATEGORY 3	CATEGORY 4	CATEGORY 5
3100	Chair, 3 legs, seat height 44 cm or 46 cm, chromed or powder coated tubular steel base	406	446	480	649	785	1.055
3101	Chair, 4 legs, seat height 44 cm or 46 cm, chromed or powder coated tubular steel base	406	446	480	649	785	1.055

FRONT UPHOLSTERED - LACQUERED

MODEL	DESCRIPTION	CHRISTIANSHAVN	CATEGORY 1	CATEGORY 2	CATEGORY 3	CATEGORY 4	CATEGORY 5
3100	Chair, 3 legs, seat height 44 cm or 46 cm, chromed or powder coated tubular steel base	420	460	494	663	799	1.070
3101	Chair, 4 legs, seat height 44 cm or 46 cm, chromed or powder coated tubular steel base	420	460	494	663	799	1.070

FRONT UPHOLSTERED - NATURAL VENEER

MODEL	DESCRIPTION	CHRISTIANSHAVN	CATEGORY 1	CATEGORY 2	CATEGORY 3	CATEGORY 4	CATEGORY 5
3100	Chair, 3 legs, seat height 44 cm or 46 cm, chromed or powder coated tubular steel base	541	582	615	785	920	1.191
3101	Chair, 4 legs, seat height 44 cm or 46 cm, chromed or powder coated tubular steel base	541	582	615	785	920	1.191

CATEGORY 1: BELFAST, CANVAS, CAPTURE, DIABLO, FAME, REMIX, TONUS

CATEGORY 2: DIVINA, DIVINA MELANGE, DIVINA MD, FIORD, HALLINGDAL, RE-WOOL, STEELCUT, STEELCUT TRIO, SUNNIVA, VANIR, VIDAR

CATEGORY 3: COMFORT, ESSENTIAL

CATEGORY 4: Soft

CATEGORY 5: Grace, Embrace, Natural

SELECTED TEXTILE COLOURS - SEE THE SURFACE SELECTION

BELFAST (770593, 770660, 771772, 772062, 772143, 772150, 772255, 774232, 774926, 775139)

VANIR (193, 243, 373, 393, 413, 443, 473, 693, 733, 773, 913, 983)

OPTIONS

DESCRIPTION	PRICE
Linking device for 3101	62
Felt glides (3 or 4 pcs.)	6
Small transport dolly for 8 chairs (3100) or 12 chairs (3101)	372
Large transport dolly for 40 chairs	710
Chair rack, mounted under a table top	53

3100

3101

SMALL AND LARGE TRANSPORT DOLLY FOR STACKABLE CHAIRS

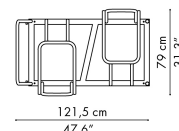
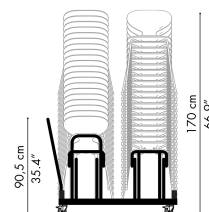
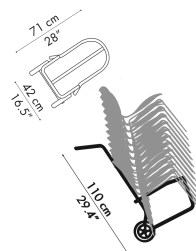
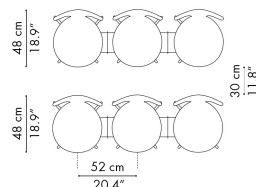
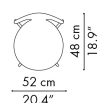
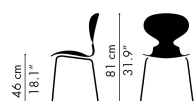



**SERIES 7™**  
**ARNE JACOBSEN 1955**

**01.2023**

The Series 7™ chair comes in three different finishes: Natural, coloured ash or lacquered veneer. All chairs are made of pressure moulded veneer. The shell is also available in front or fully upholstered versions in a wide range of textiles and leather types. Besides a base with four legs made of tubular steel, it also comes with a height-adjustable swivel base and castors, a counter or a bar stool. The bases of the Series 7™ are available with either a chromed or powder coated finish.

MODEL	DESCRIPTION	COLOURED ASH	LACQUERED	NATURAL VENEER
3107	Chair, stackable (max 12 pcs.), seat height 43 cm, 46 cm or 48 cm, chromed or powder coated tubular steel base	385	398	464
3207	Armchair, seat height 43 cm or 46 cm, chromed or powder coated tubular steel base	636	716	782
3187	Counter stool, seat height 64 cm, chromed or powder coated tubular steel base	543	557	623
3197	Bar stool, seat height 76 cm, chromed or powder coated tubular steel base	543	557	623
3117	Swivel chair, adjustable seat height 44-56 cm, 5 castors, chromed or powder coated tubular steel base	835	875	941
3217	Swivel armchair, adjustable seat height 44-56 cm, 5 castors, chromed or powder coated tubular steel base	1.074	1.167	1.233

**COLOURED ASH AND LACQUERED - SEE THE SURFACE SELECTION**

PALE ROSE (610/615), WILD ROSE (630/635), VENETIAN RED (670/675), PARADISE ORANGE (570/575), BURNT YELLOW (470/475), TRUE YELLOW (460/465), LIGHT BEIGE (130/135), DEEP CLAY (140/145), OLIVE GREEN (920/925), LAVENDER BLUE (810/815), DUSK BLUE (850/855), MIDNIGHT BLUE (890/895), EVERGREEN (950/955), BLACK (190/195), NINE GREY (150/155), WHITE (100/105)

**NATURAL VENEER VARIANTS - SEE THE SURFACE SELECTION**

MAPLE (10), BEECH (20), ASH (30), CHERRY (40), OREGON PINE (50), ELM (60), OAK (70), WALNUT (80), DARK STAINED OAK (90), FULL DARK STAINED OAK (90)

**BASE COLOURS**

SILVER GREY (170), WARM GRAPHITE (180), BROWN BRONZE (390), BLACK (190), WHITE (100, ONLY WITH WHITE SHELL, ONLY FOUR-LEGGED BASE), NINE GREY (150), CHROME

**FRONT UPHOLSTERED - COLOURED ASH**

MODEL	DESCRIPTION	CHRISTIANSHAVN	CATEGORY 1	CATEGORY 2	CATEGORY 3	CATEGORY 4	CATEGORY 5
3107	Chair, seat height 43 cm, 46 cm or 48 cm, chromed or powder coated tubular steel base	528	569	603	772	907	1.178
3207	Armchair, seat height 43 cm or 46 cm, chromed or powder coated tubular steel base	785	826	860	1.029	1.164	1.435
3187	Counter stool, seat height 64 cm, chromed or powder coated tubular steel base	690	731	765	934	1.070	1.340
3197	Bar stool, seat height 76 cm, chromed or powder coated tubular steel base	690	731	765	934	1.070	1.340
3117	Swivel chair, adjustable seat height 44-56 cm, 5 castors, chromed or powder coated tubular steel base	988	1.029	1.063	1.232	1.368	1.638
3217	Swivel armchair, adjustable seat height 44-56 cm, 5 castors, chromed or powder coated tubular steel base	1.232	1.273	1.307	1.476	1.611	1.882

**FRONT UPHOLSTERED - LACQUERED**

MODEL	DESCRIPTION	CHRISTIANSHAVN	CATEGORY 1	CATEGORY 2	CATEGORY 3	CATEGORY 4	CATEGORY 5
3107	Chair, seat height 43 cm, 46 cm or 48 cm, chromed or powder coated tubular steel base	542	582	616	785	921	1.191
3207	Armchair, seat height 43 cm or 46 cm, chromed or powder coated tubular steel base	867	907	941	1.110	1.246	1.516
3187	Counter stool, seat height 64 cm, chromed or powder coated tubular steel base	704	745	779	948	1.083	1.354
3197	Bar stool, seat height 76 cm, chromed or powder coated tubular steel base	704	745	779	948	1.083	1.354
3117	Swivel chair, adjustable seat height 44-56 cm, 5 castors, chromed or powder coated tubular steel base	1.029	1.070	1.103	1.273	1.408	1.679
3217	Swivel armchair, adjustable seat height 44-56 cm, 5 castors, chromed or powder coated tubular steel base	1.327	1.368	1.401	1.571	1.706	1.977

**FRONT UPHOLSTERED - NATURAL VENEER**

MODEL	DESCRIPTION	CHRISTIANSHAVN	CATEGORY 1	CATEGORY 2	CATEGORY 3	CATEGORY 4	CATEGORY 5
3107	Chair, seat height 43 cm, 46 cm or 48 cm, chromed or powder coated tubular steel base	609	650	684	853	988	1.259
3207	Armchair, seat height 43 cm or 46 cm, chromed or powder coated tubular steel base	934	975	1.009	1.178	1.313	1.584
3187	Counter stool, seat height 64 cm, chromed or powder coated tubular steel base	772	812	846	1.015	1.151	1.421
3197	Bar stool, seat height 76 cm, chromed or powder coated tubular steel base	772	812	846	1.015	1.151	1.421
3117	Swivel chair, adjustable seat height 44-56 cm, 5 castors, chromed or powder coated tubular steel base	1.097	1.137	1.171	1.340	1.476	1.747
3217	Swivel armchair, adjustable seat height 44-56 cm, 5 castors, chromed or powder coated tubular steel base	1.395	1.435	1.469	1.638	1.774	2.044

**CATEGORY 1: BELFAST, CANVAS, CAPTURE, DIABLO, FAME, REMIX, TONUS**

**CATEGORY 2: DIVINA, DIVINA MELANGE, DIVINA MD, FIORD, HALLINGDAL, RE-WOOL, STEELCUT, STEELCUT TRIO, SUNNIVA, VANIR**

**CATEGORY 3: COMFORT, ESSENTIAL**

**CATEGORY 4: SOFT**

**CATEGORY 5: GRACE, EMBRACE, NATURAL**

**SELECTED TEXTILE COLOURS - SEE THE SURFACE SELECTION**

BELFAST (770593, 770660, 771772, 772062, 772143, 772150, 772255, 774232, 774926, 775139)  
VANIR (193, 243, 373, 393, 413, 443, 473, 693, 733, 773, 913, 983)



FULLY UPHOLSTERED

MODEL	DESCRIPTION	CHRISTIANSHAVN	CATEGORY 1	CATEGORY 2	CATEGORY 3	CATEGORY 4	CATEGORY 5
3107	Chair, seat height 43 cm, 46 cm or 48 cm, chromed or powder coated tubular steel base	609	636	676	907	1.110	1.543
3207	Armchair, seat height 43 cm or 46 cm, chromed or powder coated tubular steel base	826	867	907	1.137	1.354	1.692
3187	Counter stool, seat height 64 cm, chromed or powder coated tubular steel base	812	853	894	1.124	1.300	1.557
3197	Bar stool, seat height 76 cm, chromed or powder coated tubular steel base	812	853	894	1.124	1.300	1.557
3117	Swivel chair, adjustable seat height 44-56 cm, 5 castors, chromed or powder coated tubular steel base	1.002	1.056	1.110	1.300	1.516	1.787
3217	Swivel armchair, adjustable seat height 44-56 cm, 5 castors, chromed or powder coated tubular steel base	1.286	1.354	1.422	1.625	1.841	2.139

CATEGORY 1: BELFAST, CANVAS, CAPTURE, DIABLO, FAME, REMIX, TONUS

CATEGORY 2: DIVINA, DIVINA MELANGE, DIVINA MD, FIORD, HALLINGDAL, RE-WOOL, STEELCUT, STEELCUT TRIO, SUNNIVA, VANIR

CATEGORY 3: COMFORT, ESSENTIAL

CATEGORY 4: SOFT

CATEGORY 5: GRACE, EMBRACE, RUSTIK, NATURAL

SELECTED TEXTILE COLOURS - SEE THE SURFACE SELECTION

BELFAST (770593, 770660, 771772, 772062, 772143, 772150, 772255, 774232, 774926, 775139)

VANIR (193, 243, 373, 393, 413, 443, 473, 693, 733, 773, 913, 983)

OPTIONS

DESCRIPTION	PRICE
Hard castors for soft floors without brake	-
Soft castor for hard floors without brake	-
Hard castor for soft floors with brake	-
Soft castor for hard floors with brake	-
Linking device for 3107, short	62
Linking device for 3107 w/writing tablet and 3207, long	62
Writing tablet for 3107, fold-away, white laminated surface, chromed arm	291
Small transport dolly for 12 pcs. 3107 chairs, non-upholstered	372
Large transport dolly for 40 pcs. 3107 chairs, non-upholstered	710
Felt glides (4 pcs.)	6
Chair rack for 3107 chairs, mounted under a table top, for non-upholstered chairs only	53
3107SC Seat cushion, Wild leather, walnut	88
3107SC Seat cushion, Raw leather, black (colli 12 pcs.)	63
3107SC Seat cushion, Intense leather, brown (colli 12 pcs.)	63



3107

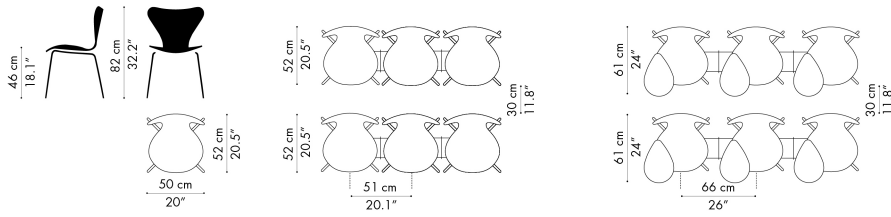

3207

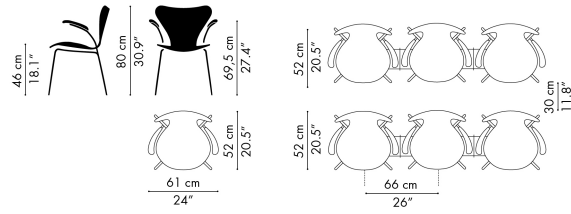

3187

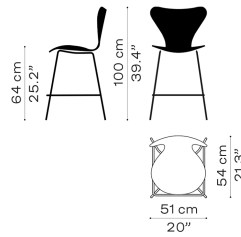

3197

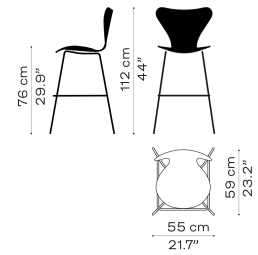

3117

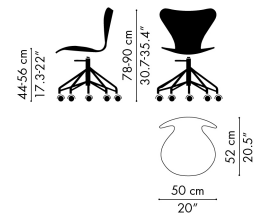

3217

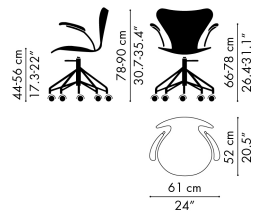

SMALL AND LARGE TRANSPORT DOLLY FOR STACKABLE CHAIRS

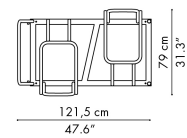
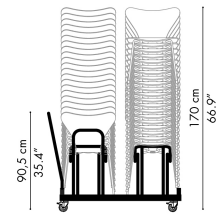
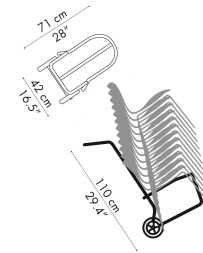





**SERIES 7™ CHILDREN'S CHAIR / JUNIOR**  
ARNE JACOBSEN 2005/2019

01.2023

The Children's Chair is available in coloured ash in three colours. The base comes with 4 legs (stackable) and is made of powder coated steel tubes in colours matching the shell.

The Junior chair is available in natural oak or black coloured ash with a chromed steel base, coloured ash in Evergreen or Burned Yellow with Brown Bronze base.

**SERIES 7™ CHILDREN'S CHAIR / JUNIOR CHAIR**

MODEL	DESCRIPTION	PRICE
840232	Children's chair, stackable (max 10 pcs.), seat height 34 cm, Rose (626), powder coated tubular steel base matching the shell - colli 2	265
840233	Children's chair, stackable (max 10 pcs.), seat height 34 cm, Lavender blue (885) powder coated tubular steel base matching the shell - colli 2	265
840234	Children's chair, stackable (max 10 pcs.), seat height 34 cm, Black (195), powder coated tubular steel base matching the shell - colli 2	265
840236	Junior chair, seat height 52 cm, Black, chromed tubular steel base	306
840237	Junior chair, seat height 52 cm, Oak veneer, chromed tubular steel base	306
840238	Junior chair, seat height 52, Burnt Yellow, Brown Bronze powder coated tubular steel base	306
840239	Junior chair, seat height 52, Evergreen, Brown Bronze powder coated tubular steel base	306

**SERIES 7™ CHILDREN'S CHAIR**

**SERIES 7™ JUNIOR CHAIR**

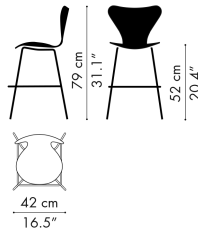
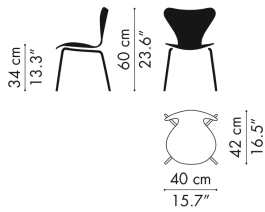



**DOT™ / HIGH DOT™**  
**ARNE JACOBSEN 1954**

**01.2023**

The Dot™ and the High Dot™ stools are available in three leather variants and two textile variants. The Dot™ comes with four legs, while the High Dot™ has a three-legged base with a foot rest made of chromed or powder coated tubular steel.

MODEL	DESCRIPTION	LEATHER
840105	Dot™ stool, seat height 46 cm, Intense leather matt black, black powder coated tubular steel base (colli 2)	265
840100	Dot™ stool, seat height 46 cm, Wild leather Walnut, chromed tubular steel base (colli 2)	265
840109	Dot™ stool, seat height 46 cm, buffed leather Lava, chromed tubular steel base (colli 2)	265
840112	Dot™ stool, seat height 46 cm, Ria textile, White/Purple (111), Warm Graphite powder coated tubular steel base	265
840113	Dot™ stool, seat height 46 cm, Ria textile, Grey/Beige/White (241), Warm Graphite powder coated tubular steel base	265
840106	High Dot™ stool, seat height 65 cm, Intense leather Matt black, black powder coated tubular steel base	353
840107	High Dot™ stool, seat height 65 cm, Walnut Wild leather, chromed tubular steel base	353
840108	High Dot™ stool, seat height 65 cm, buffed leather Lava, chromed tubular steel base	353

**DOT™**

**HIGH DOT™**

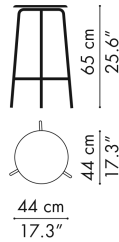
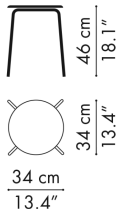



**GRAND PRIX™**  
**ARNE JACOBSEN 1957**

**01.2023**

The Grand Prix™ comes in oak and walnut, coloured ash or lacquered (only 3130) veneer. All chairs are made of pressure moulded veneer. Front upholstery or full upholstery is available in a wide range of textiles and leather types. The base comes with four legs in several variants: Chromed or powder coated tubular steel (stackable max 5 pcs.) and wooden legs (non-stackable).

MODEL	DESCRIPTION	COLOURED ASH	LACQUERED	OAK, WALNUT
3130	Chair, stackable (max 5 pcs.), seat height 43 cm, 46 cm or 48 cm, chromed or powder coated tubular steel base	385	398	464
4130	Chair, seat height 43 cm or 46 cm, wooden legs	531		551

**COLOURED ASH AND LACQUERED - SEE THE SURFACE SELECTION**

PALE ROSE (610/615), WILD ROSE (630/635), VENETIAN RED (670/675), PARADISE ORANGE (570/575), BURNT YELLOW (470/475), TRUE YELLOW (460/465), LIGHT BEIGE (130/135), DEEP CLAY (140/145), OLIVE GREEN (920/925), LAVENDER BLUE (810/815), DUSK BLUE (850/855), MIDNIGHT BLUE (890/895), EVERGREEN (950/955), BLACK (190/195), NINE GREY (150/155), WHITE (100/105)

**BASE COLOURS**

3130: SILVER GREY (170), WARM GRAPHITE (180), BROWN BRONZE (390), BLACK (190), WHITE (100, ONLY WITH WHITE SHELL), NINE GREY (150), CHROME  
4130\*: OAK (70), WALNUT (80), BLACK (195), NINE GREY (155), WHITE (105, ONLY WITH WHITE SHELL)

[\*OAK/WALNUT VENEER SHELLS ARE ONLY AVAILABLE WITH MATCHING WOODEN BASE]

**FRONT UPHOLSTERED - COLOURED ASH**

MODEL	DESCRIPTION	CHRISTIANSHAVN	CATEGORY 1	CATEGORY 2	CATEGORY 3	CATEGORY 4	CATEGORY 5
3130	Chair, seat height 43 cm, 46 or 48 cm, chromed or powder coated tubular steel base	528	569	603	772	907	1.178
4130	Chair, seat height 43 cm or 46 cm, wooden legs	677	718	752	921	1.056	1.327

**FRONT UPHOLSTERED - LACQUERED**

MODEL	DESCRIPTION	CHRISTIANSHAVN	CATEGORY 1	CATEGORY 2	CATEGORY 3	CATEGORY 4	CATEGORY 5
3130	Chair, seat height 43 cm, 46 or 48 cm, chromed or powder coated tubular steel base	542	582	616	785	921	1.191

**FRONT UPHOLSTERED - OAK AND WALNUT**

MODEL	DESCRIPTION	CHRISTIANSHAVN	CATEGORY 1	CATEGORY 2	CATEGORY 3	CATEGORY 4	CATEGORY 5
3130	Chair, seat height 43 cm, 46 or 48 cm, chromed or powder coated tubular steel base	609	650	684	853	988	1.259
4130	Chair, seat height 43 cm or 46 cm, wooden legs	698	739	773	942	1.077	1.348

CATEGORY 1: CANVAS, CAPTURE, DIABLO, FAME, REMIX, TONUS

CATEGORY 2: DIVINA, DIVINA MELANGE, DIVINA MD, FIORD, HALLINGDAL, RE-WOOL, STEELCUT, STEELCUT TRIO, SUNNIVA, VANIR

CATEGORY 3: COMFORT, ESSENTIAL

CATEGORY 4: SOFT

CATEGORY 5: GRACE, EMBRACE, NATURAL

SELECTED TEXTILE COLOURS - SEE THE SURFACE SELECTION

VANIR (193, 243, 373,393, 413, 443, 473, 693, 733, 773, 913, 983)

**FULLY UPHOLSTERED**

MODEL	DESCRIPTION	CHRISTIANSHAVN	CATEGORY 1	CATEGORY 2	CATEGORY 3	CATEGORY 4	CATEGORY 5
3130	Chair, seat height 43 cm, 46 or 48 cm, chromed or powder coated tubular steel base	609	636	676	907	1.110	1.543
4130	Chair, seat height 43 cm or 46 cm, wooden legs	762	789	830	1.061	1.264	1.697

CATEGORY 1: CANVAS, CAPTURE, DIABLO, FAME, REMIX, TONUS

CATEGORY 2: DIVINA, DIVINA MELANGE, DIVINA MD, FIORD, HALLINGDAL, RE-WOOL, STEELCUT, STEELCUT TRIO, SUNNIVA, VANIR

CATEGORY 3: COMFORT, ESSENTIAL

CATEGORY 4: SOFT

CATEGORY 5: GRACE, EMBRACE, RUSTIK, NATURAL

SELECTED TEXTILE COLOURS - SEE THE SURFACE SELECTION

VANIR (193, 243, 373,393, 413, 443, 473, 693, 733, 773, 913, 983)

**OPTIONS**

DESCRIPTION	PRICE
Linking device for 3130 chairs	62
Small transport dolly for 5 pcs. 3130 chairs, non-upholstered	372
Chair rack for 3130 chairs, mounted under a table top, for non-upholstered chairs only	53
Felt glides (4 pcs.)	6



3130

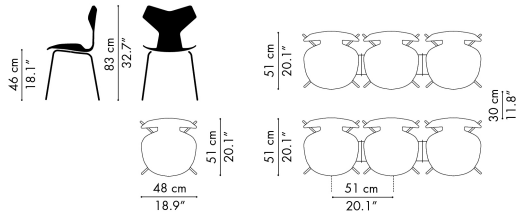

4130

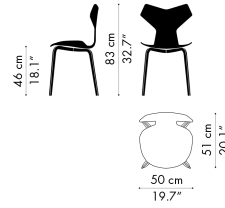

SMALL TRANSPORT DOLLY FOR STACKABLE CHAIRS

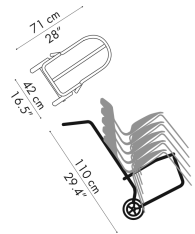



The Lily™ chair comes in two variants; with or without arms, in walnut veneer or fully upholstered in a wide range of textiles and leather types. All chairs are made of pressure moulded veneer. The base comes with four legs made of chromed tubular steel.

MODEL	DESCRIPTION	NATURAL WALNUT VENEER
3108	Chair, stackable (max 8 pcs.), seat height 43 cm or 46 cm, chromed tubular steel base	588
3208	Armchair, seat height 43 cm or 46 cm, chromed tubular steel base	1.045

FULLY UPHOLSTERED

MODEL	DESCRIPTION	CHRISTIANSHAVN	CATEGORY 1	CATEGORY 2	CATEGORY 3	CATEGORY 4	CATEGORY 5
3108	Chair, seat height 43 cm or 46 cm, chromed tubular steel base	987	1.039	1.039	1.473	1.795	2.506
3208	Armchair, seat height 43 cm or 46 cm, chromed tubular steel base	2.089	2.199	2.199	2.448	2.848	3.598

CATEGORY 1: CANVAS, CAPTURE, DIABLO, FAME, REMIX, TONUS  
 CATEGORY 2: DIVINA, DIVINA MELANGE, DIVINA MD, FIORD, HALLINGDAL, RE-WOOL, STEELCUT, STEELCUT TRIO, SUNNIVA, VANIR  
 CATEGORY 3: COMFORT, ESSENTIAL  
 CATEGORY 4: SOFT  
 CATEGORY 5: GRACE, EMBRACE, RUSTIK, NATURAL

SELECTED TEXTILE COLOURS - SEE THE SURFACE SELECTION  
 VANIR (193, 243, 373,393, 413, 443, 473, 693, 733, 773, 913, 983)

OPTIONS

DESCRIPTION	PRICE
Felt glides (4 pcs.)	6
Linking device for 3108	62
Small transport dolly for 8 pcs. 3108 chairs, non-upholstered	372
Chair rack for 3108 chairs, mounted under a table top, for non-upholstered chairs only	53

3108 3208 SMALL TRANSPORT DOLLY

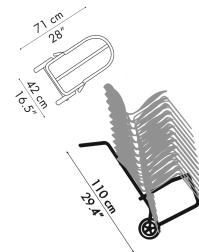
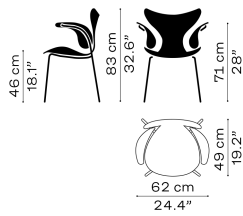
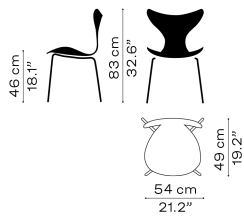



**DROP™**  
ARNE JACOBSEN 1958/2014

01.2023

The Drop™ chair comes with a shell made of ABS plastic and four legs in chromed or powder coated tubular steel. The chair is also available upholstered in a wide range of textile and leather types.

**PLASTIC**

MODEL	DESCRIPTION	PLASTIC
3110	Chair, 43 cm or 46 cm, chromed or powder coated tubular steel base	273

PLASTIC COLOURS - SEE THE SURFACE SELECTION  
DEEP CLAY (145), LIGHT BEIGE (135), PALE ROSE (615), OLIVE GREEN (925), BLACK (201), WHITE (101)

BASE COLOURS  
WARM GRAPHITE (180), BROWN BRONZE (390), BLACK (190), WHITE (100, ONLY WITH WHITE SHELL), CHROME

**FULLY UPHOLSTERED**

MODEL	DESCRIPTION	CHRISTIANSHAVN	CATEGORY 1	CATEGORY 2	CATEGORY 3	CATEGORY 4	CATEGORY 5
3110	Chair, 43 cm or 46 cm, handstitched, chromed or powder coated tubular steel base	838	882	939	1.455	1.595	1.877
3110UB	Chair, 43 cm or 46 cm, Essential leather with front stitching and piping, chrome or powder coated tubular steel base				925		

CATEGORY 1: CANVAS, CAPTURE, DIABLO, FAME, REMIX, TONUS  
CATEGORY 2: DIVINA, DIVINA MELANGE, DIVINA MD, FIORD, HALLINGDAL, RE-WOOL, STEELCUT, STEELCUT TRIO, SUNNIVA  
CATEGORY 3: COMFORT, ESSENTIAL  
CATEGORY 4: AURA  
CATEGORY 5: GRACE, EMBRACE, RUSTIK, NATURAL

**OPTIONS**

DESCRIPTION	PRICE
Felt glides (4 pcs.)	6
3110SC Seat cushion, Salsa 3 textile, grey (36)	50
3110SC Seat cushion, Salsa 3 textile, black (39)	50

3110/3110UB

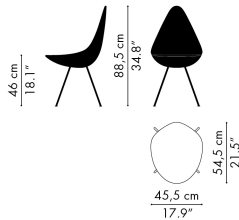



**LITTLE GIRAFFE™**  
**ARNE JACOBSEN 1959/2018**

**01.2023**

The Little Giraffe™ chair is upholstered with either a fixed or a removable cover in a wide selection of textiles and leather types. Seat and backrest of the chair are made from PUR-foam moulded around an inner steel frame. Its base is available either with four tubular steel legs or a five-star base made of die-cast aluminium.

MODEL	DESCRIPTION	CHRISTIANSHAVN	CATEGORY 1	CATEGORY 2	CATEGORY 3	CATEGORY 4	CATEGORY 5
3201	Chair, fixed cover, 4 legs, chromed or black powder coated tubular steel base	974	1.026	1.162	1.709	2.120	2.530
3201R	Chair, removable cover, 4 legs, chromed or black powder coated tubular steel base	1.072	1.128	1.279			
3211	Swivel chair, fixed cover, height-adjustable, satin polished or black powder coated aluminium base, 5 castors	1.169	1.231	1.367	1.915	2.325	2.735
3211R	Swivel chair, removable cover, height-adjustable, satin polished or black powder coated aluminium base, 5 castors	1.286	1.354	1.504			
32C	Removable cover, in textile only	286	301	342			

CATEGORY 1: CANVAS, CAPTURE, DIABLO, FAME, REMIX, TONUS  
 CATEGORY 2: DIVINA, DIVINA MELANGE, DIVINA MD, FIORD, HALLINGDAL, RE-WOOL, STEELCUT, STEELCUT TRIO, SUNNIVA  
 CATEGORY 3: COMFORT (3201 & 3211), ESSENTIAL  
 CATEGORY 4: AURA  
 CATEGORY 5: GRACE, EMBRACE, RUSTIK, NATURAL

BASE COLOURS  
 FOUR-LEGGED BASE: BLACK (190), CHROME  
 SWIVEL BASE: BLACK (190), SATIN POLISHED ALUMINIUM

**OPTIONS**

DESCRIPTION	PRICE
Hard castors for soft floors without brake	-
Soft castors for hard floors, without brake	-
Hard castors for soft floors, with brake	-
Soft castors for hard floors, with brake	-

**3201**

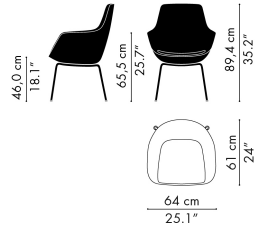

**3211**

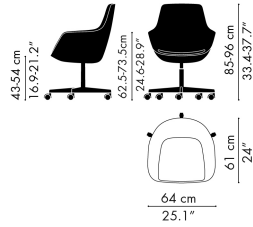



The Oxford™ chair comes fully upholstered in a wide range of textile or leather types and is available with a low or medium back, with or without armrests. The inner shell of the chair is made of a pressure moulded veneer shell covered with cut HR foam. The base of the chair is made of die-cast aluminium and available either as a fixed four-star or five-star base with or without castors, either fixed or height adjustable with tilt mechanism. The bases come in two finishes; satin polished or powder coated aluminium, while the five-star base is also optionally available in mirror chrome. Optional comfort-enhancing arm pads are available for armrest configurations.

**4-STAR BASE**

MODEL	DESCRIPTION	CHRISTIANSHAVN	CATEGORY 1	CATEGORY 2	CATEGORY 3	CATEGORY 4	CATEGORY 5
3141T	Chair, low back, fixed seat height, toes	1.631	1.716	1.820	2.063	2.366	3.276
3143T	Chair, medium back, fixed seat height, toes	1.814	1.911	2.026	2.299	2.633	3.573
3241T	Armchair, low back, fixed seat height, toes	1.826	1.911	2.014	2.256	2.560	3.470
3243T	Armchair, medium back, fixed seat height, toes	2.008	2.105	2.220	2.493	2.827	3.767

**5-STAR BASE**

MODEL	DESCRIPTION	CHRISTIANSHAVN	CATEGORY 1	CATEGORY 2	CATEGORY 3	CATEGORY 4	CATEGORY 5
3171T	Chair, low back, fixed seat height, glides or toes	1.753	1.838	1.941	2.184	2.487	3.397
3173T	Chair, medium back, fixed height, glides or toes	1.935	2.032	2.147	2.420	2.754	3.694
3191T	Chair, low back, height adjustable, tilt, glides or toes	1.814	1.899	2.002	2.245	2.548	3.458
3193T	Chair, medium back, height adjustable, tilt, glides or toes	1.996	2.093	2.208	2.481	2.815	3.755
3271T	Armchair, low back, fixed seat height, glides or toes	1.947	2.032	2.135	2.378	2.681	3.591
3273T	Armchair, medium back, fixed seat height, glides or toes	2.129	2.227	2.341	2.614	2.948	3.889
3291T	Armchair, low back, height adjustable, tilt, glides or toes	2.008	2.093	2.196	2.439	2.742	3.652
3293T	Armchair, medium back, height adjustable, tilt, glides or toes	2.190	2.287	2.402	2.675	3.009	3.949

**5-STAR BASE WITH CASTORS**

MODEL	DESCRIPTION	CHRISTIANSHAVN	CATEGORY 1	CATEGORY 2	CATEGORY 3	CATEGORY 4	CATEGORY 5
3171W	Chair, low back, fixed seat height, castors	2.020	2.105	2.208	2.451	2.754	3.664
3173W	Chair, medium back, fixed seat height, castors	2.202	2.299	2.415	2.688	3.021	3.961
3191W	Chair, low back, height adjustable, tilt, castors	2.081	2.166	2.269	2.511	2.815	3.725
3193W	Chair, medium back, height adjustable, tilt, castors	2.262	2.360	2.475	2.748	3.082	4.022
3271W	Armchair, low back, fixed seat height, castors	2.214	2.299	2.402	2.645	2.948	3.858
3273W	Armchair, medium back, fixed seat height, castors	2.396	2.493	2.609	2.882	3.215	4.155
3291W	Armchair, low back, height adjustable, tilt, castors	2.275	2.360	2.463	2.705	3.009	3.919
3293W	Armchair, medium back, height adjustable, tilt, castors	2.457	2.554	2.669	2.942	3.276	4.216

CATEGORY 1: CANVAS, CAPTURE, DIABLO, FAME, REMIX, TONUS  
 CATEGORY 2: DIVINA, DIVINA MELANGE, DIVINA MD, FIORD, HALLINGDAL, STEELCUT, STEELCUT TRIO, SUNNIVA, RE-WOOL, VIDAR  
 CATEGORY 3: COMFORT, ESSENTIAL, SONAR  
 CATEGORY 4: SOFT  
 CATEGORY 5: GRACE, EMBRACE, RUSTIK, NATURAL

BASE COLOURS: WARM GRAPHITE (180), BROWN BRONZE (390), BLACK (190), SATIN POLISHED ALUMINIUM, CHROME

**OPTIONS**

PRICE

Hard castors for soft floors, without brake	-
Soft castors for hard floors, without brake	-
Hard castors for soft floors, with brake	-
Soft castors for hard floors, with brake	-
Automatic return for chairs with fixed seat height	143
Arm pads in black plastic for chairs upholstered in textile	30
Arm pads in matching leather for chairs upholstered in leather	91
Mirror chromed base (5-star bases)	91
Mirror chromed base and armrests (5-star bases)	182





3141T

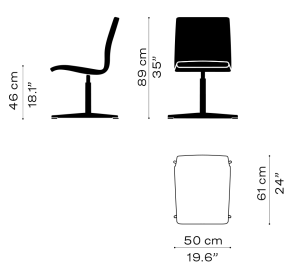

3143T

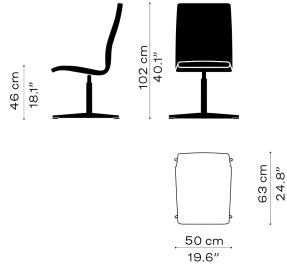

3241T

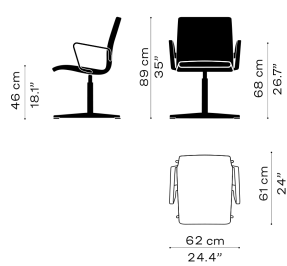

3243T

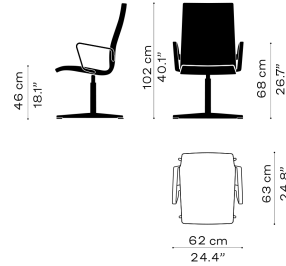

3171T

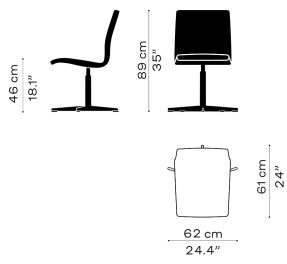

3173T

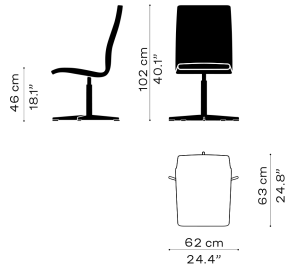

3191T

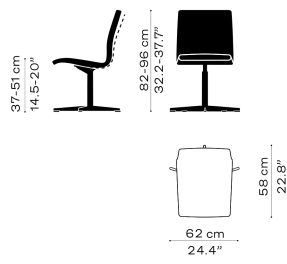

3193T

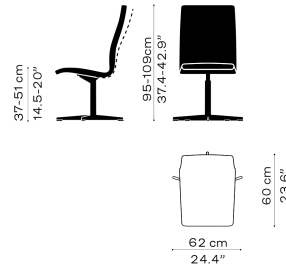

3271T

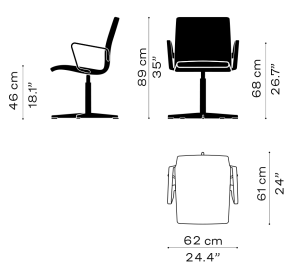

3273T

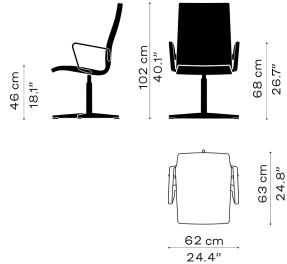

3291T

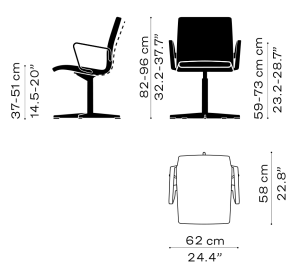

3293T

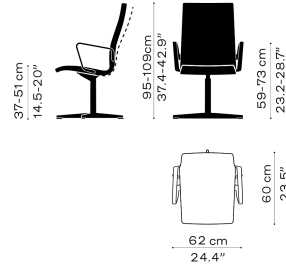

3171W

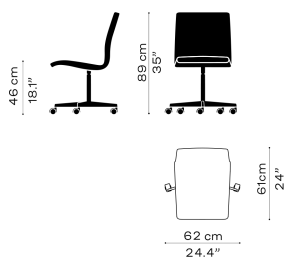

3173W

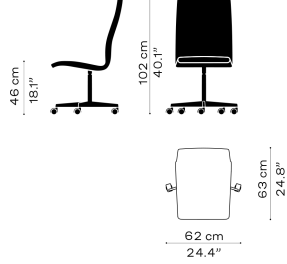

3191W

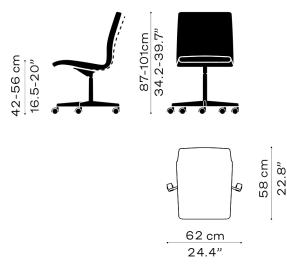

3193W

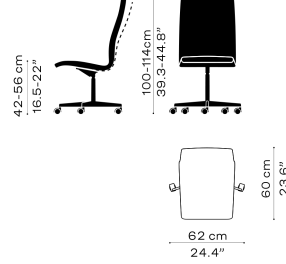

3271W

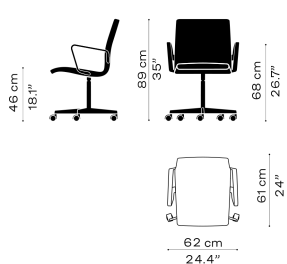

3273W

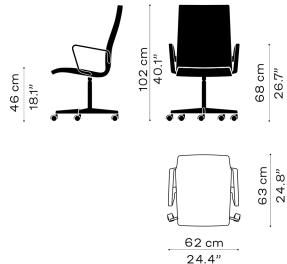

3291W

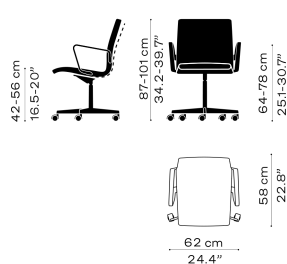

3293W

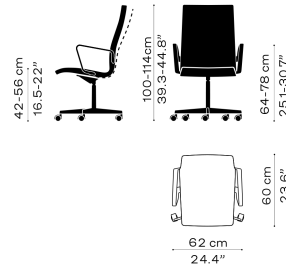



## N01™ NENDO 2018

01.2023

The N01™ armchair is made of a solid wood base with seat and backrest in pressure moulded veneer. The fully wooden chair is available in natural beech, natural oak and black coloured oak. Optionally, a seat cushion made of textile or leather is available, which can either be mounted with a Velcro fastener or purchased separately as a loose cushion.

MODEL	DESCRIPTION	BEECH	BLACK COLOURED OAK	OAK
N01	Armchair, seat height 44 cm or 46,5 cm, solid wood base	615	684	684

### OPTIONS

MODEL	DESCRIPTION	PRICE
N70	Seat cushion (loose) in Remix textile dark blue/grey (173), beige (233) or dark brown (393)	68
N70	Seat cushion (loose) in Raw leather, black	86
N71	Seat cushion (fixed, incl. Velcro) in Remix textile dark blue/grey (173), beige (233) or dark brown (393)	96
N71	Seat cushion (fixed, incl. Velcro), in Raw leather, black	123

### N01

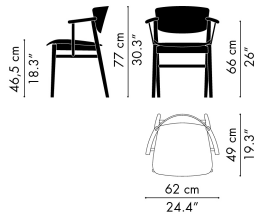



# N02™ RECYCLE NENDO 2019

01.2023

N02™ Recycle is made from PP plastic recycled from household waste. It is available in seven shell colours with four legs made of tubular steel, a sledge base made of solid steel or a die-cast aluminium swivel base. The N02™ Recycle is also configurable as counter or bar stool with a four-legged base. The chair is available with an optional seat cushion in textile, mounted or sold separately.

MODEL	DESCRIPTION	RECYCLED PLAST
N02-10	Chair, stackable (max 10 pcs.), seat height 46 cm, 4 legs, chromed or powder coated tubular steel	244
N02-11	Armchair, stackable (max 10 pcs.), seat height 46 cm, 4 legs, chromed or powder coated tubular steel	325
N02-20	Chair, stackable (max 10 pcs.), seat height 46 cm, chromed solid steel sledge base	244
N02-21	Chair w/welded linking device, stackable (max 10 pcs.), seat height 46 cm, chromed steel sledge base	284
N02-30	Swivel chair, polished aluminium base, 5 castors	433
N02-31	Swivel armchair, polished aluminium base, 5 castors	515
N02-40	Counter stool, stackable (max 4 pcs.), seat height 64 cm, chromed or powder coated tubular steel base	293
N02-50	Bar stool, stackable (max 4 pcs.), seat height 76 cm, chromed or powder coated tubular steel base	347

SHELL AND BASE COLOURS  
OFF WHITE (115), GREY (175), BLACK (215), DARK ORANGE (575), DARK RED (675), LIGHT BLUE (815), DARK BLUE (875)

OPTIONS DESCRIPTION	PRICE
Hard castors for soft floors without brake	-
Soft castor for hard floors without brake	-
Hard castor for soft floors with brake	-
Soft castor for hard floors with brake	-
N02-70 Seat cushion, Just textile in black (60999), dark grey (60121) or light grey (60118)	54
Linking device for N02-20	28
Felt glides (4 pcs.)	6
Small transport dolly for 10 pcs. N02-10, N02-11 or N02-20 chairs	372
Chair rack for N02 chairs, mounted under a table top	53

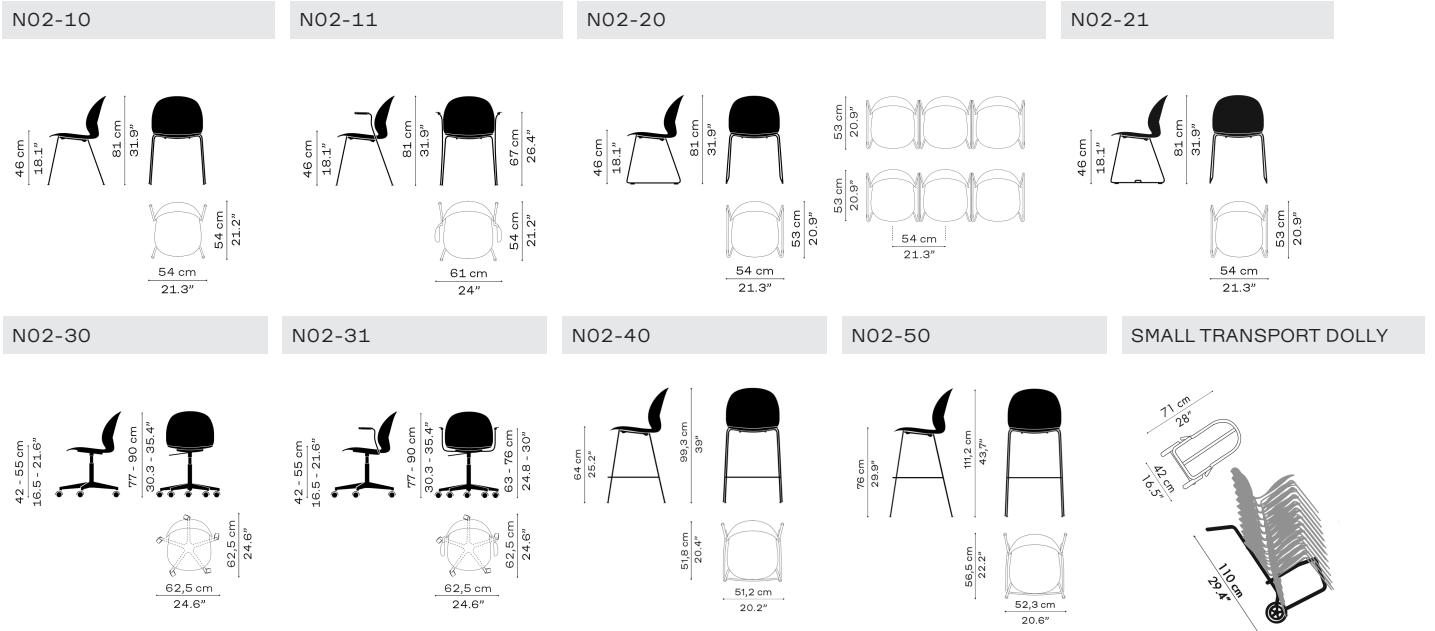

CERTIFICATION  
The N02™ Recycle models N02-10 and N02-11 with powder coated legs have achieved the EU-Ecolabel.





**NAP™**  
KASPER SALTO 2010

The NAP™ chair comes with a nylon plastic shell with a high-gloss back and a matt rippled front. The chair is available in four shell colours with a four-legged base. The base is either made of tubular steel with a chromed or powder coated finish matching the shell or a four-legged wooden base made of pressure moulded veneer. The NAP™ is also configurable as counter or bar stool with a four-legged base. All variants are configurable with or without armrests. The chair is also available with a seat cushion in textile, mounted or purchased separately.

MODEL	DESCRIPTION	PLASTIC
KS50	Chair, stackable (max 8 pcs.), seat height 45 cm, chromed or powder coated tubular steel base	311
KS52	Chair, seat height 45 cm, oak veneer legs	361
KS58	Counter stool, seat height 64 cm, chromed tubular steel base	560
KS59	Bar stool, seat height 76 cm, chromed tubular steel base	560
KS60	Armchair, stackable (max 8 pcs.), seat height 45 cm, chromed or powder coated tubular steel base	415
KS62	Armchair, seat height 45 cm, oak veneer legs	455
KS68	Counter stool with armrests, seat height 64 cm, chromed tubular steel base	664
KS69	Bar stool with armrests, seat height 76 cm, chromed tubular steel base	664

PLASTIC COLOURS - SEE THE SURFACE SELECTION  
MILK WHITE (106), SILVER GREY (166), PEPPER GREY (176), MIDNIGHT BLUE (876)

**OPTIONS**  
DESCRIPTION

DESCRIPTION	PRICE
Small transport dolly for 8 pcs. KS50 or KS60 chairs	372
KS70 seat cushion, Divina Melange textile Light grey (120) or Dark grey (180)	100

KS50      KS52      KS60      KS62

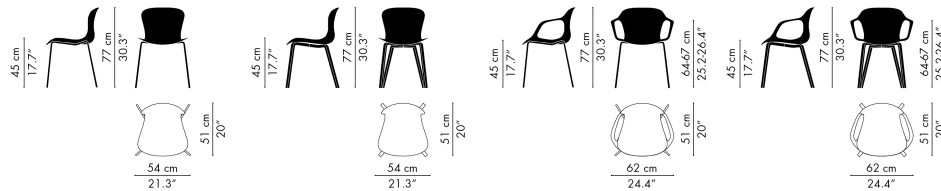

KS58      KS59      KS68      KS69      SMALL TRANSPORT DOLLY

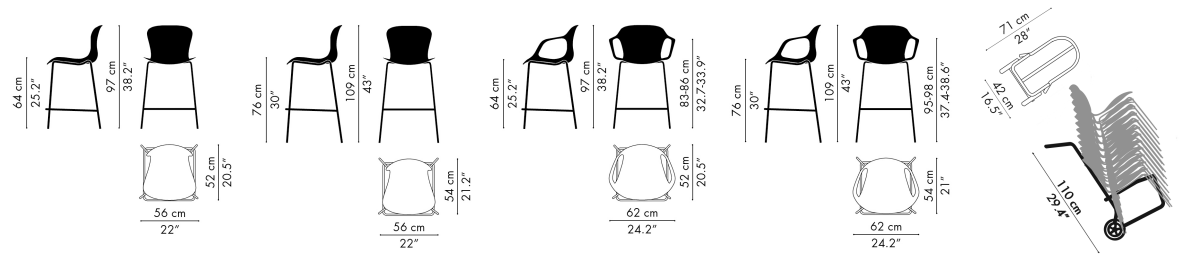



**VICO DUO™**  
VICO MAGISTRETTI 1997/2020

01.2023

The Vico Duo™ chair comes with a pressure moulded veneer shell and is available in two different finishes: Natural veneer or black coloured ash. The shell is also available in front or fully upholstered versions in a wide range of textiles and leather types. Besides a four-legged tubular steel base, the Vico Duo™ is configurable with a sledge base made of solid steel, or as counter or bar stool with a four-legged tubular steel base. The chair is also available with a seat cushion in textile, mounted or purchased separately. Armrests are available on the models detailed below.

MODEL	DESCRIPTION	BLACK COLOURED ASH	NATURAL VENEER
VM110	Chair, stackable (max 10 pcs.), seat height 46 cm, 4 legs, chromed or black powder coated tubular steel base	272	272
VM111	Armchair, stackable (max 8 pcs.), seat height 46 cm, 4 legs, chromed or black powder coated tubular steel base	329	329
VM112	Chair w/welded linking device, stackable (max 8 pcs.), seat height 46 cm, 4 legs, chromed or black powder coated tubular steel base	363	363
VM113	Armchair w/welded linking device, stackable (max 8 pcs.), seat height 46 cm, 4 legs, chromed or black powder coated tubular steel base	445	445
VM114	Chair, stackable (max 8 pcs.), seat height 46 cm, chromed steel sledge base	272	272
VM115	Chair w/welded linking device, stackable (max 8 pcs.), seat height 46 cm, chromed steel sledge base	322	322
VM116	Counter stool, stackable (max 4 pcs.), seat height 64 cm, chromed or black powder coated tubular steel base	338	338
VM118	Bar stool, stackable (max 4 pcs.), seat height 76 cm, chromed or black powder coated tubular steel base	404	404

NATURAL VENEER VARIANTS - SEE THE SURFACE SELECTION  
OAK (70), WALNUT (80)

**FRONT UPHOLSTERED - COLOURED ASH**

MODEL	DESCRIPTION	CHRISTIANSHAVN	CATEGORY 1	CATEGORY 2	CATEGORY 3	CATEGORY 4	CATEGORY 5
VM110	Chair, seat height 46 cm, 4 legs with arms, chromed or black powder coated tubular steel base	355	388	437	519	618	783
VM111	Armchair, seat height 46 cm, 4 legs, chromed or black powder coated tubular steel base	411	444	494	576	675	840
VM112	Chair w/welded linking device, seat height 46 cm, 4 legs, chromed or black powder coated tubular steel base	445	478	527	610	709	874
VM113	Armchair w/welded linking device, seat height 46 cm, 4 legs, chromed or black powder coated tubular steel base	527	560	610	692	791	956
VM114	Chair, seat height 46 cm, chromed steel sledge base	355	388	437	519	618	783
VM115	Chair w/welded linking device, seat height 46 cm, chromed steel sledge base	404	437	486	569	668	832
VM116	Counter stool, seat height 64 cm, chromed or black powder coated tubular steel base	420	453	503	585	684	849
VM118	Bar stool, seat height 76 cm, chromed or black powder coated tubular steel base	486	519	569	651	750	915

**FRONT UPHOLSTERED - NATURAL VENEER**

MODEL	DESCRIPTION	CHRISTIANSHAVN	CATEGORY 1	CATEGORY 2	CATEGORY 3	CATEGORY 4	CATEGORY 5
VM110	Chair, seat height 46 cm, 4 legs with arms, chromed or black powder coated tubular steel base	355	388	437	519	618	783
VM111	Armchair, seat height 46 cm, 4 legs, chromed or black powder coated tubular steel base	411	444	494	576	675	840
VM112	Chair w/welded linking device, seat height 46 cm, 4 legs, chromed or black powder coated tubular steel base	445	478	527	610	709	874
VM113	Armchair w/welded linking device, seat height 46 cm, 4 legs, chromed or black powder coated tubular steel base	527	560	610	692	791	956
VM114	Chair, seat height 46 cm, chromed steel sledge base	355	388	437	519	618	783
VM115	Chair w/welded linking device, seat height 46 cm, chromed steel sledge base	404	437	486	569	668	832
VM116	Counter stool, seat height 64 cm, chromed or black powder coated tubular steel base	420	453	503	585	684	849
VM118	Bar stool, seat height 76 cm, chromed or black powder coated tubular steel base	486	519	569	651	750	915

CATEGORY 1: BELFAST, CANVAS, CAPTURE, DIABLO, FAME, REMIX, TONUS  
 CATEGORY 2: DIVINA, DIVINA MELANGE, DIVINA MD, FIORD, HALLINGDAL, RE-WOOL, STEELCUT, STEELCUT TRIO, SUNNIVA  
 CATEGORY 3: COMFORT, ESSENTIAL  
 CATEGORY 4: SOFT  
 CATEGORY 5: GRACE, EMBRACE, NATURAL

SELECTED TEXTILE COLOURS - SEE THE SURFACE SELECTION  
 BELFAST (770593, 770660, 771772, 772062, 772143, 772150, 772255, 774232, 774926, 775139)  
 VANIR (193, 243, 373, 393, 413, 443, 473, 693, 733, 773, 913, 983)



FULLY UPHOLSTERED

MODEL	DESCRIPTION	CHRISTIANSHAVN	CATEGORY 1	CATEGORY 2	CATEGORY 3	CATEGORY 4	CATEGORY 5
VM110	Chair, seat height 46 cm, 4 legs with arms, chromed or black powder coated tubular steel base	396	429	478	610	775	1.071
VM111	Armchair, seat height 46 cm, 4 legs, chromed or black powder coated tubular steel base	452	486	535	667	832	1.128
VM112	Chair w/welded linking device, seat height 46 cm, 4 legs, chromed or black powder coated tubular steel base	486	519	569	700	866	1.162
VM113	Armchair w/welded linking device, seat height 46 cm, 4 legs, chromed or black powder coated tubular steel base	569	602	651	783	948	1.244
VM114	Chair, seat height 46 cm, chromed steel sledge base	396	429	478	610	775	1.071
VM115	Chair w/welded linking device, seat height 46 cm, chromed steel sledge base	445	478	528	659	824	1.121
VM116	Counter stool, seat height 64 cm, chromed or black powder coated tubular steel base	462	494	544	676	841	1.137
VM118	Bar stool, seat height 76 cm, chromed or black powder coated tubular steel base	528	560	610	742	907	1.203

CATEGORY 1: BELFAST, CANVAS, CAPTURE, DIABLO, FAME, REMIX, TONUS  
 CATEGORY 2: DIVINA, DIVINA MELANGE, DIVINA MD, FIORD, HALLINGDAL, RE-WOOL, STEELCUT, STEELCUT TRIO, SUNNIVA  
 CATEGORY 3: COMFORT, ESSENTIAL  
 CATEGORY 4: SOFT  
 CATEGORY 5: GRACE, EMBRACE, RUSTIK, NATURAL

SELECTED TEXTILE COLOURS - SEE THE SURFACE SELECTION  
 BELFAST (770593, 770660, 771772, 772062, 772143, 772150, 772255, 774232, 774926, 775139  
 VANIR (193, 243, 373, 393, 413, 443, 473, 693, 733, 773, 913, 983)

OPTIONS

DESCRIPTION	PRICE
Linking device for VM114	28
Small transport dolly for 10 pcs. Vico Duo chairs without arms (except counter and bar stool) and 8 pcs. with arms, non-upholstered	372
Felt glides (4 pcs.)	6
VM170 seat cushion, Just textile black (60999) or dark grey (60121)	53

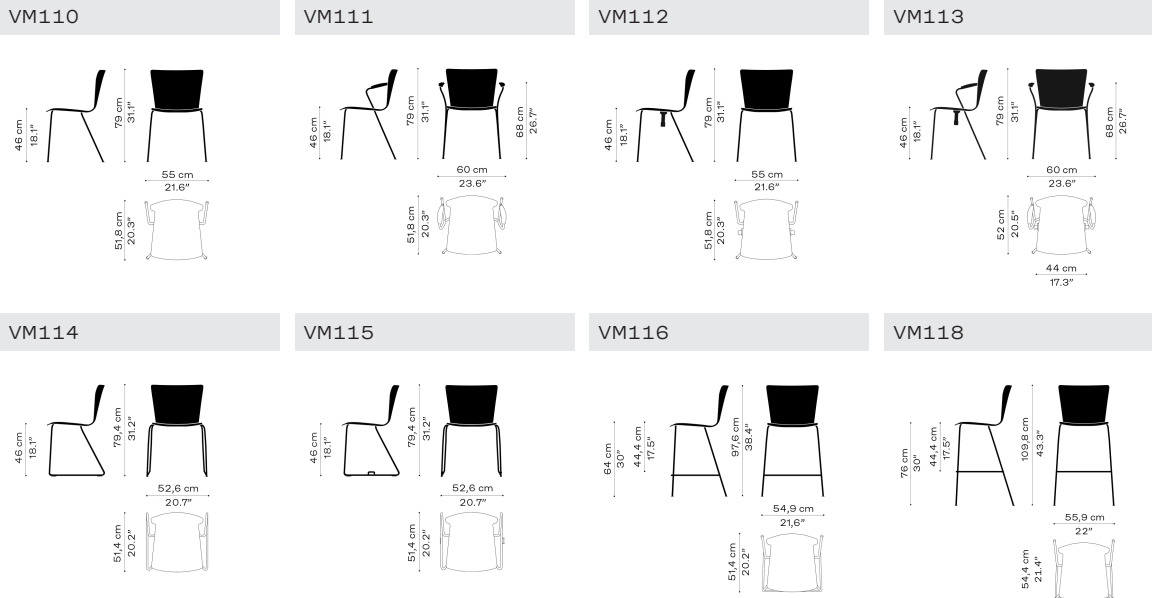

SMALL TRANSPORT DOLLY

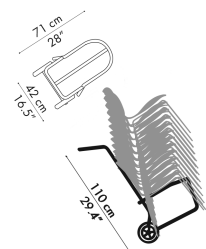



**CHINA CHAIR™**  
**HANS J. WEGNER 1944**

**01.2023**

The China Chair™ is available in two types of solid wood: Lacquered cherry and black coloured ash. The chair comes with an integrated loose seat cushion, upholstered in leather and available in various leather types.

MODEL	DESCRIPTION	CATEGORY 4	CATEGORY 5
4283	Armchair, seat height 45 cm, solid wood, lacquered cherry	7.392	7.699
4283	Armchair, seat height 45 cm, solid wood, black coloured ash	5.892	6.199
4283SC	Replacement seat cushion (loose)	1.012	1.318

CATEGORY 4: AURA  
 CATEGORY 5: GRACE, EMBRACE, RUSTIK, NATURAL

**4283**

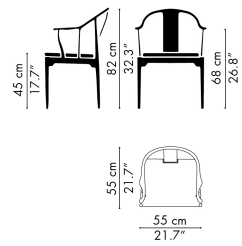



**SERIES 3300™**  
**ARNE JACOBSEN 1956**

**01.2023**

Series 3300™ is available both as a lounge chair and a 2- or 3-seater sofa. Its frame is made of chromed tubular steel, while the cushions are made of cut HR foam covering a wooden base structure. The cushions come fully upholstered in a wide range of textiles and leather types. See page 32 for sofas.

MODEL	DESCRIPTION	CHRISTIANSHAVN	CATEGORY 1	CATEGORY 2	CATEGORY 3	CATEGORY 4	CATEGORY 5
3300	Lounge chair, chromed tubular steel base	3.856	4.059	4.303	6.140	7.567	8.810

CATEGORY 1: CANVAS, CAPTURE, DIABLO, FAME, REMIX, TONUS  
 CATEGORY 2: DIVINA, DIVINA MELANGE, DIVINA MD, FIORD, HALLINGDAL, RE-WOOL, STEELCUT, STEELCUT TRIO, SUNNIVA  
 CATEGORY 3: COMFORT, ESSENTIAL  
 CATEGORY 4: AURA  
 CATEGORY 5: GRACE, EMBRACE, RUSTIK, NATURAL

3300

SEE PAGE 32 FOR SOFAS

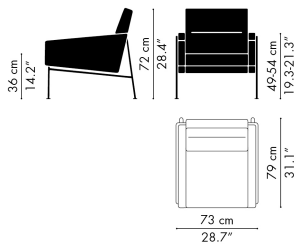





**EGG™**  
ARNE JACOBSEN 1958

01.2023

The Egg™ lounge chair comes fully upholstered in a wide range of textiles and leather types. The four-star base consists either of a satin chromed steel column connected to a base in satin polished aluminium or a powder coated steel column connected to a base in powder coated aluminium. The inner shell is made of a hard moulded foam, padded with a softer foam structure to increase comfort. A matching Egg™ footstool is available in the same base and upholstery options as the Egg™ lounge chair.

MODEL	DESCRIPTION	CHRISTIANSHAVN	CATEGORY 1	CATEGORY 2	CATEGORY 3	CATEGORY 4	CATEGORY 5
3316	Lounge chair, 4-star base, tilt and swivel	5.677	5.976	6.332	8.361	10.618	12.322
3127	Footstool, 4-star base	1.724	1.814	1.865	2.012	2.254	2.577

CATEGORY 1: CANVAS, CAPTURE, DIABLO, FAME, RIME, TONUS  
 CATEGORY 2: DIVINA, DIVINA MELANGE, DIVINA MD, FIORD, HALLINGDAL, RE-WOOL, STEELCUT, STEELCUT TRIO, SUNNIVA  
 CATEGORY 3: COMFORT, ESSENTIAL  
 CATEGORY 4: AURA  
 CATEGORY 5: GRACE, EMBRACE, RUSTIK, NATURAL

BASE COLOURS  
 SILVER GREY (170), WARM GRAPHITE (180), BROWN BRONZE (390), BLACK (190), ALUMINIUM

**OPTIONS**

DESCRIPTION	PRICE
Automatic return for 3316	155

3316

3127

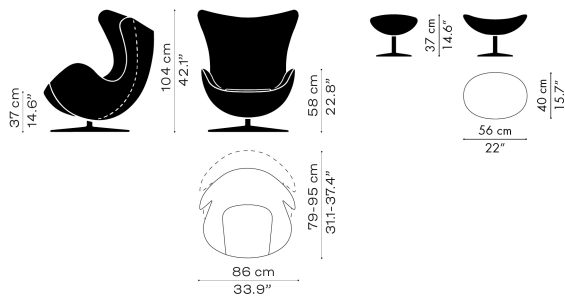



The Swan™ lounge chair comes fully upholstered in a wide range of textiles and leather types. The four-star base consists either of a satin chromed steel column connected to a base in satin polished aluminium or a powder coated steel column connected to a base in powder coated aluminium. The inner shell is made of a hard moulded foam, padded with a softer foam structure to increase comfort.

MODEL	DESCRIPTION	CHRISTIANSHAVN	CATEGORY 1	CATEGORY 2	CATEGORY 3	CATEGORY 4	CATEGORY 5
3320	Lounge chair, 4-star base, swivel	3.208	3.377	3.578	4.883	5.671	6.638

CATEGORY 1: CAPTURE, DIABLO, FAME, RIME, TONUS  
 CATEGORY 2: DIVINA, DIVINA MELANGE, DIVINA MD, FIORD, HALLINGDAL, RE-WOOL, STEELCUT, STEELCUT TRIO, SUNNIVA  
 CATEGORY 3: COMFORT, ESSENTIAL  
 CATEGORY 4: AURA  
 CATEGORY 5: GRACE, EMBRACE, RUSTIK, NATURAL

BASE COLOURS  
 SILVER GREY (170), WARM GRAPHITE (180), BROWN BRONZE (390), BLACK (190), ALUMINIUM

**OPTIONS**

DESCRIPTION	PRICE
Automatic return for 3320	155
Special seat height: 48 cm	42

**3320**

**3320 + 8 CM**

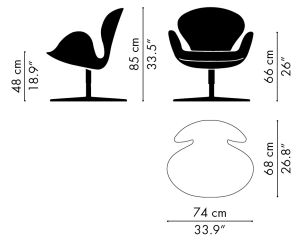
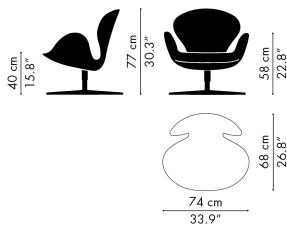



**OKSEN™**  
**ARNE JACOBSEN 1968/2017**

**01.2023**

Oksen™ lounge chair comes in three different leather types: Aura and Grace in the colours black and walnut as well as in Essential leather. The five-star base is available in black powder coated aluminium or satin polished aluminium with a satin polished steel column. A matching Oksen™ footstool is available in the same base and upholstery options as the Oksen™ lounge chair.

MODEL	DESCRIPTION	CATEGORY 3	CATEGORY 4	CATEGORY 5
4201	Lounge chair, swivel, satin polished aluminium or black powder coated aluminium	8.369	10.461	11.856
4210	Footstool, satin polished aluminium or black powder coated aluminium	2.092	2.511	2.789

CATEGORY 3: ESSENTIAL  
 CATEGORY 4: AURA (Black or Walnut)  
 CATEGORY 5: GRACE (Black or Walnut)

**OPTIONS**  
 DESCRIPTION

PRICE

Automatic return for 4201	155
---------------------------	-----

4201

4210

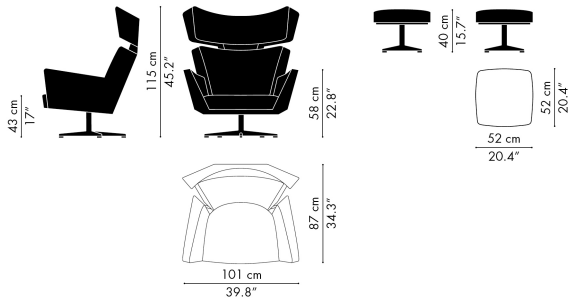



**POT™**  
**ARNE JACOBSEN 1959/2017**

**01.2023**

The Pot™ lounge chair comes fully upholstered in a wide range of textiles and leather types. The inner shell is made of a hard moulded foam, padded with a softer foam structure to increase comfort. The lounge chair's base consists of four legs in chromed or Brown Bronze powder coated tubular steel.

MODEL	DESCRIPTION	CHRISTIANSHAVN	CATEGORY 1	CATEGORY 2	CATEGORY 3	CATEGORY 4	CATEGORY 5
3318	Lounge chair, chromed or Brown Bronze powder coated tubular steel base	1.429	1.504	1.641	2.188	2.598	3.008

CATEGORY 1: CANVAS, CAPTURE, DIABLO, FAME, REMIX, RIME, TONUS  
 CATEGORY 2: DIVINA, DIVINA MELANGE, DIVINA MD, FIORD, HALLINGDAL, RE-WOOL, STEELCUT, STEELCUT TRIO, SUNNIVA  
 CATEGORY 3: COMFORT, ESSENTIAL  
 CATEGORY 4: AURA  
 CATEGORY 5: GRACE, EMBRACE, RUSTIK, NATURAL

3318

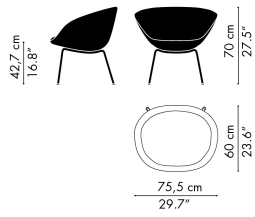



RO™  
JAIME HAYON 2013

01.2023

The Ro™ lounge chair comes fully upholstered in a wide range of textiles. Single textile or a mix of two textiles; one textile for the shell and one for the cushions. The base is available with four legs in brushed aluminium or solid oak with a clear lacquer finish. A matching Ro™ footstool is available in the same base and upholstery options as the Ro™ lounge chair. In 2022, designer Jaime Hayon has curated a new and exclusive textile selection for his Ro™ and Fri™ lounge chairs for Fritz Hansen, resting on four legs in brushed aluminium.

MODEL	DESCRIPTION	CHRISTIANSHAVN	CATEGORY 1	CATEGORY 2	CATEGORY 3	CATEGORY 4
JH1	Lounge chair, brushed aluminium legs	2.528	2.654	2.654	3.413	4.045
JH2	Lounge chair, solid oak legs	2.528	2.654	2.654	3.413	4.045
JH11	Footstool, brushed aluminium legs	745	783	783	935	973
JH12	Footstool, solid oak legs	745	783	783	935	973

CATEGORY 1: CANVAS (ONLY CUSHIONS & FOOTSTOOL), CAPTURE, DIABLO (ONLY CUSHIONS & FOOTSTOOL), FAME, MOOD, REMIX (ONLY CUSHIONS & FOOTSTOOL), RIME, TONUS  
 CATEGORY 2: DIVINA, DIVINA MD, DIVINA MELANGE, FIORD, HALLINGDAL, NABIS, RE-WOOL, SAFIRE, STEELCUT, STEELCUT TRIO, SUNNIVA, TWILL WEAVE  
 CATEGORY 3: VIDAR, RAAS  
 CATEGORY 4: ATOM

Designer selection	Shell	Cushion	Price
JH1 Pale Rose, brushed aluminium legs	Steelcut 605	Nabis 0011	2.528
JH1 Mint Green, brushed aluminium legs	Steelcut 935	Nabis 0023	2.528
JH1 Atom Green, brushed aluminium legs	Atom 964	Atom 964	4.045
JH11 Pale Rose, brushed aluminium legs	Steelcut 605	Nabis 0011	783
JH11 Mint Green, brushed aluminium legs	Steelcut 935	Nabis 0023	783
JH11 Atom Green, brushed aluminium legs	Atom 964	Atom 964	973

JH1

JH2

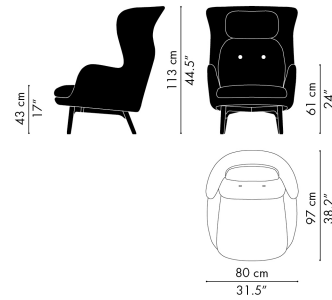
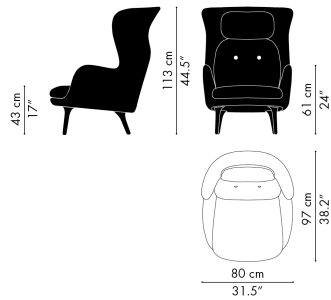

JH11

JH12

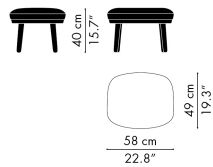
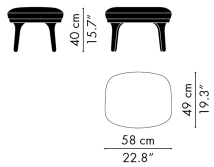



**FRI™**  
**JAIME HAYON 2015**

**01.2023**

The Fri™ lounge chair comes fully upholstered in a wide range of textiles. Single textile or a mix of two textiles; one textile for the shell and one for the cushions. The base is available with four legs in brushed aluminium or solid oak with a clear lacquer finish. A matching Fri™ footstool is available in the same base and upholstery options as the Fri™ lounge chair. In 2022, designer Jaime Hayon has curated a new and exclusive textile selection for his Ro™ and Fri™ lounge chairs for Fritz Hansen, resting on four legs in brushed aluminium.

MODEL	DESCRIPTION	CHRISTIANSHAVN	CATEGORY 1	CATEGORY 2	CATEGORY 3	CATEGORY 4
JH4	Lounge chair, brushed aluminium legs	2.275	2.402	2.402	3.034	3.792
JH5	Lounge chair, solid oak legs	2.275	2.402	2.402	3.034	3.792
JH14	Footstool, brushed aluminium legs	745	783	783	935	973
JH15	Footstool, solid oak legs	745	783	783	935	973

CATEGORY 1: CANVAS, CAPTURE, FAME, REMIX, RIME, TONUS  
 CATEGORY 2: DIVINA, DIVINA MD, DIVINA MELANGE, FIORD, HALLINGDAL, RE-WOOL, SAFIRE, STEELCUT, STEELCUT TRIO, SUNNIVA  
 CATEGORY 3: VIDAR  
 CATEGORY 4: ATOM

Designer selection	Shell	Cushion	Price
JH4 Burnt Yellow, brushed aluminium legs	Remix 422	Vidar 472	2.275
JH4 Atom White, brushed aluminium legs	Atom 124	Atom 124	3.792
JH14 Burnt Yellow, brushed aluminium legs	Remix 422	Vidar 472	783
JH14 Atom White, brushed aluminium legs	Atom 124	Atom 124	973

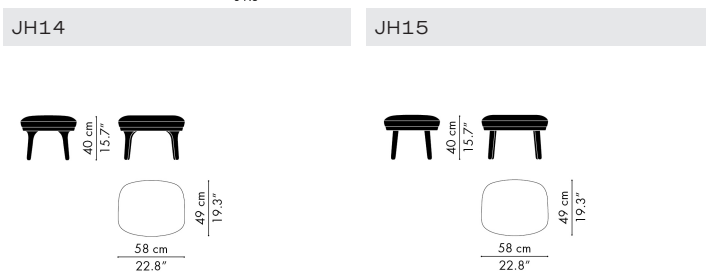
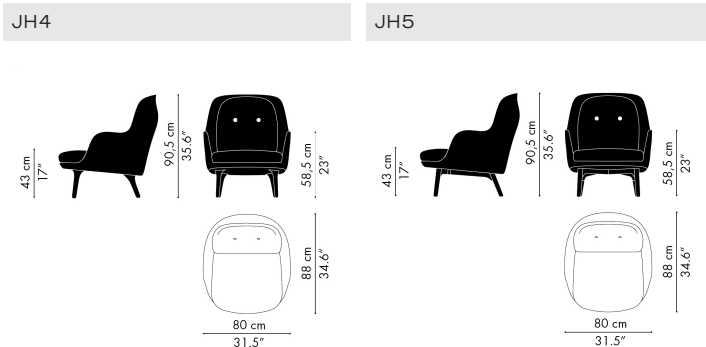



**VIA57™**  
**BJARKE INGELS IN COLLABORATION WITH KIBISI 2016**

**01.2023**

VIA57™ lounge chair comes fully upholstered in a range of textiles. The wooden base is made of solid oak with a clear lacquer finish. Seat and back are composed of soft moulded PE foam around an inner steel frame.

MODEL	DESCRIPTION	CHRISTIANSHAVN	CATEGORY 1	CATEGORY 2	CATEGORY 3
BIO1	Lounge chair, solid oak base	2.007	2.031	2.113	2.538

CATEGORY 1: CAPTURE, MESSENGER, TONUS  
 CATEGORY 2: DIVINA, DIVINA MD, DIVINA MELANGE, FIORD, HALLINGDAL, MERIT, RE-WOOL, STEELCUT, STEELCUT TRIO, SUNNIVA  
 CATEGORY 3: GENTLE

**BIO1**

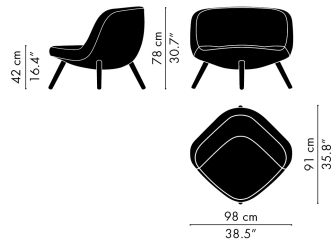



**FRED™**  
**JAIME HAYON 2019**

**01.2023**

The Fred™ lounge chair is available in two types of solid wood and a total of four different finishes: Black painted ash, walnut stained oak, clear lacquered oak or oiled oak. The upholstered cushions are available in a variety of textile and leather types.

MODEL	DESCRIPTION	CHRISTIANSHAVN	CATEGORY 1	CATEGORY 2	CATEGORY 3	CATEGORY 4
JH97	Lounge chair, Black painted ash	1.770	1.841	1.947	2.265	2.619
JH97	Lounge chair, Walnut stained oak	1.770	1.841	1.947	2.265	2.619
JH97	Lounge chair, Clear lacquered oak	1.841	1.911	2.017	2.336	2.690
JH97	Lounge chair, Oiled oak	1.841	1.911	2.017	2.336	2.690

CATEGORY 1: BELFAST  
 CATEGORY 2: HARALD, HALLINGDAL, RE-WOOL  
 CATEGORY 3: ESSENTIAL  
 CATEGORY 4: RIA

SELECTED TEXTILE COLOURS - SEE THE SURFACE SELECTION  
 BELFAST (770593, 770660, 771772, 772062, 772143, 772150, 772255, 774232, 774926, 775139)

**JH97**

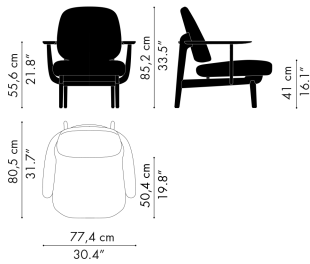





**LET™**  
**SEBASTIAN HERKNER 2020**

**01.2023**

The Let™ lounge chair comes fully upholstered and is available in a wide range of textiles and leather. Inner seat and backrest of the chair are made from PUR-foam moulded around an inner steel frame. The four-legged base of the Let™ lounge chair is available either in solid wood or tubular steel. The wooden bases come with a lacquered oak, lacquered ash or black coloured ash finish, while steel bases are available in chrome or powder coated in Black, Warm Graphite or Brown Bronze.

MODEL	DESCRIPTION	CHRISTIANSHAVN	CATEGORY 1	CATEGORY 2	CATEGORY 3
SH200	Lounge chair, wooden base	1.457	1.530	1.603	1.749
SH210	Lounge chair, chromed or powder coated tubular steel base	1.394	1.464	1.534	1.673

CATEGORY 1: CANVAS, REMIX, FAME, TONUS, HUE

CATEGORY 2: DIVINA, DIVINA MD, DIVINA MELANGE, FIORD, HALLINGDAL, RE-WOOL, STEELCUT, STEELCUT TRIO, SUNNIVA, VIDAR

CATEGORY 3: ESSENTIAL

**BASE COLOURS**

SH200: LACQUERED OAK, LACQUERED ASH OR BLACK COLOURED ASH

SH210: WARM GRAPHITE (180), BROWN BRONZE (390), BLACK (190), CHROME

**SH200**

**SH210**

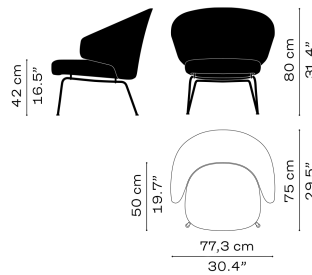
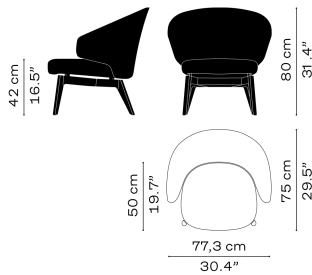

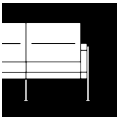

**SERIES 3300™**  
**ARNE JACOBSEN 1956**

01.2023

Series 3300™ is available both as a lounge chair and a 2- or 3-seater sofa. Its frame is made of chromed tubular steel, while the cushions are made of cut HR foam covering a wooden base structure. The cushions come fully upholstered in a wide range of textiles and leather types. See page 22 for lounge chair.

MODEL	DESCRIPTION	CHRISTIANSHAVN	CATEGORY 1	CATEGORY 2	CATEGORY 3	CATEGORY 4	CATEGORY 5
3302	2-seater sofa, chromed tubular steel base	5.721	6.022	6.383	9.107	10.881	12.649
3303	3-seater sofa, chromed tubular steel base	7.588	7.987	8.465	11.904	14.192	16.702
	Additional modules for Series 3300, chromed tubular steel base	1.865	1.963	2.081	2.967	3.314	3.840

CATEGORY 1: CANVAS, CAPTURE, DIABLO, FAME, REMIX, TONUS  
 CATEGORY 2: DIVINA, DIVINA MELANGE, DIVINA MD, FIORD, HALLINGDAL, RE-WOOL, STEELCUT, STEELCUT TRIO, SUNNIVA  
 CATEGORY 3: COMFORT, ESSENTIAL  
 CATEGORY 4: AURA  
 CATEGORY 5: GRACE, EMBRACE, RUSTIK, NATURAL

3302

3303

SEE PAGE 22 FOR LOUNGE CHAIR

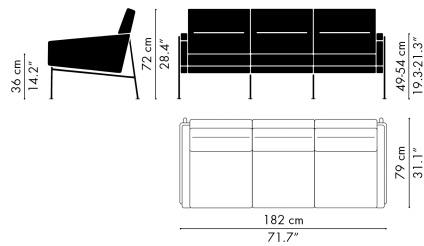
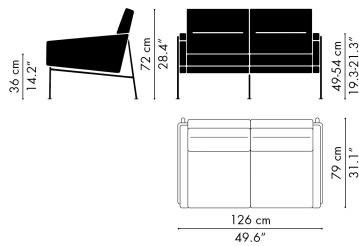



**SWAN SOFA™**  
**ARNE JACOBSEN 1958**

**01.2023**

The Swan™ sofa comes fully upholstered in a wide range of textiles and leather types. The sofa rests on a shaker base in satin polished aluminium. The inner shell is made of a hard molded foam, padded with a comfort-enhancing foam structure with lower density.

MODEL	DESCRIPTION	CHRISTIANSHAVN	CATEGORY 1	CATEGORY 2	CATEGORY 3	CATEGORY 4	CATEGORY 5
3321	2-seater sofa, shaker base, satin polished aluminium	6.873	7.235	7.667	9.817	11.401	13.013

CATEGORY 1: CAPTURE, DIABLO, FAME, TONUS  
 CATEGORY 2: DIVINA, DIVINA MELANGE, DIVINA MD, FIORD, HALLINGDAL, RE-WOOL, STEELCUT, STEELCUT TRIO, SUNNIVA  
 CATEGORY 3: COMFORT, ESSENTIAL  
 CATEGORY 4: AURA  
 CATEGORY 5: GRACE, EMBRACE, RUSTIK, NATURAL

**3321**

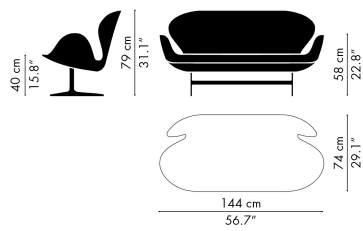



**LISSONI SOFA™**  
**PIERO LISSONI 2006**

01.2023

The Lissoni™ sofa is a fully upholstered sofa and comes in a variety of sizes. The sofa cushions consist of a core of cut foam and a channel sewed comfort-enhancing cover stuffed with synthetic flakes and feathers. The frame is either made of matt polished stainless steel or powder coated steel. The Lissoni™ sofa is available in a wide range of textiles and leather types.

MODEL	DESCRIPTION	CHRISTIANSHAVN	CATEGORY 1	CATEGORY 2	CATEGORY 3	CATEGORY 4	CATEGORY 5
PL112S	2-seater sofa, length 168 cm, powder coated steel frame	3.868	4.072	4.657	5.356	5.908	7.680
PL112S	2-seater sofa, length 168 cm, matt polished stainless steel frame	4.669	4.914	5.621	6.464	7.130	9.269
PL112	2-seater sofa, length 198 cm, powder coated steel frame	4.935	5.195	5.942	6.833	7.538	9.799
PL112	2-seater sofa, length 198 cm, matt polished stainless steel frame	5.831	6.138	7.020	8.073	8.905	11.577
PL113S	3-seater sofa, length 243 cm, powder coated steel frame	6.003	6.319	7.228	8.312	9.143	11.886
PL113S	3-seater sofa, length 243 cm, matt polished stainless steel frame	6.936	7.301	8.351	9.604	10.564	13.734
PL113	3-seater sofa, length 288 cm, powder coated steel frame	7.336	7.722	8.834	10.159	11.175	14.528
PL113	3-seater sofa, length 288 cm, matt polished stainless steel frame	8.540	8.989	9.719	11.177	12.295	15.983

CATEGORY 1: CANVAS, CAPTURE, DIABLO, FAME, REMIX, TONUS  
 CATEGORY 2: DIVINA, DIVINA MELANGE, DIVINA MD, FIORD, HALLINGDAL, RE-WOOL, STEELCUT, STEELCUT TRIO, SUNNIVA  
 CATEGORY 3: COMFORT, ESSENTIAL  
 CATEGORY 4: SOFT  
 CATEGORY 5: GRACE, EMBRACE, RUSTIK, NATURAL

BASE COLOURS  
 WARM GRAPHITE (180), BROWN BRONZE (390), BLACK (190), MATT POLISHED STAINLESS STEEL

PL112S

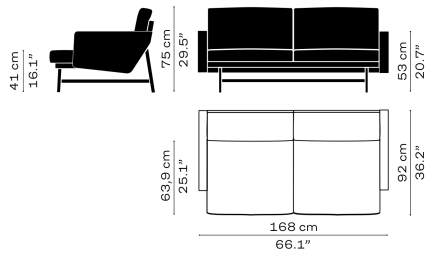

PL112

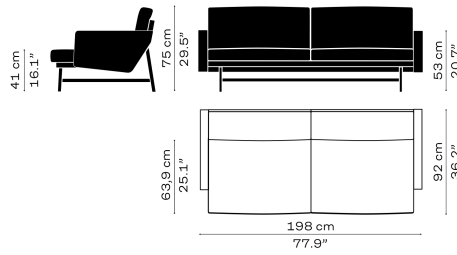

PL113S

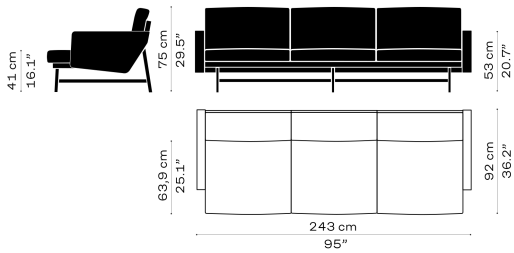

PL113

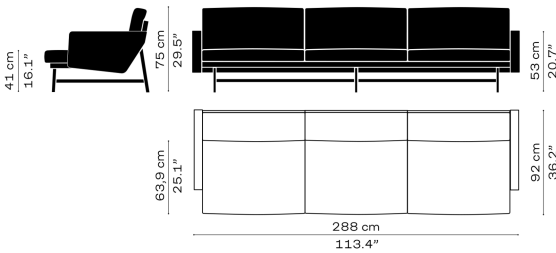



**ALPHABET™ SOFA SERIES**  
PIERO LISSONI 2008

01.2023

The Alphabet™ Sofa Series is a modular sofa system with units that can be combined in a variety of ways. The fully upholstered seat, back and armrest units come in a wide range of textiles, which can be removed for cleaning or replacement. You can choose to include a piping along the edges on both seat, back and armrests.

MODEL	DESCRIPTION	CHRISTIANSHAVN	CATEGORY 1	CATEGORY 2
PL210-1	2-seater sofa, 1 corner backrest, 1 backrest, 1 armrest	4.198	4.418	4.653
PL210-2	2-seater sofa, 1 corner backrest, 1 backrest, 1 armrest	4.198	4.418	4.653
PL210-3	2-seater sofa, 1 corner backrest, 1 backrest	3.683	3.877	4.092
PL210-4	2-seater sofa, 1 corner backrest, 1 backrest	3.683	3.877	4.092
PL240-1	2-seater sofa, 1 backrest, 2 armrests	4.263	4.486	4.712
PL240-2	2-seater sofa, 1 corner backrest, 1 backrest, 1 armrest	4.468	4.703	4.957
PL240-3	2-seater sofa, 1 corner backrest, 1 backrest, 1 armrest	4.468	4.703	4.957
PL240-4	2-seater sofa, 1 corner backrest, 1 backrest	3.888	4.091	4.316
PL240-5	2-seater sofa, 1 corner backrest, 1 backrest	3.888	4.091	4.316
PL255-1	3-seater sofa, 1 backrest, 2 armrests	4.988	5.251	5.519
PL270-1	3-seater sofa, 1 backrest, 2 armrests	5.137	5.407	5.680
PL300-1	3-seater sofa, 1 corner backrest, 2 backrests, 1 armrest	5.806	6.111	6.435
PL300-2	3-seater sofa, 1 corner backrest, 2 backrests, 1 armrest	5.806	6.111	6.435
PL300-3	4-seater sofa, 1 corner backrest, 2 backrests	6.608	6.956	7.340
PL300-4	4-seater sofa, 1 corner backrest, 2 backrests	6.608	6.956	7.340

MODEL	DESCRIPTION	CHRISTIANSHAVN	CATEGORY 1	CATEGORY 2
PL75-105	Sofa seat unit	953	1.003	1.056
PL90-105	Sofa seat unit	1.047	1.102	1.162
PL120-105	Sofa seat unit	1.192	1.254	1.320
PL120-120	Sofa seat unit	1.310	1.379	1.465

**BASE UNITS - BACK**

MODEL	DESCRIPTION	CHRISTIANSHAVN	CATEGORY 1	CATEGORY 2
PL75-30	Sofa back unit	508	535	554
PL90-30	Sofa back unit	561	591	620
PL120-30	Sofa back unit	621	653	686
PL150-30	Sofa back unit	746	786	832
PL180-30	Sofa back unit	831	875	924
PL240-30	Sofa back unit	969	1.020	1.082
PL255-30	Sofa back unit	1.031	1.086	1.149
PL270-30	Sofa back unit	1.086	1.143	1.204
PL90-90-30	Corner backrest	765	805	845

**BASE UNITS - ARMREST**

MODEL	DESCRIPTION	CHRISTIANSHAVN	CATEGORY 1	CATEGORY 2
PL60-30	Armrest	455	479	495

**OPTIONS**

MODEL	DESCRIPTION	CHRISTIANSHAVN	CATEGORY 1	CATEGORY 2
PL001	Additional sofa cushion (1 pcs.)	137	145	158
	Alphabet covers are available for all modules at 35% of the module price	-	-	-
	Piping along the edges on both seat, back and armrests is available at no additional cost	-	-	-

CATEGORY 1: CANVAS, CAPTURE, DIABLO, FAME, HUE, REMIX, TONUS  
CATEGORY 2: DIVINA, DIVINA MELANGE, DIVINA MD, FIORD, HALLINGDAL, KARAKORUM, RE-WOOL, STEELCUT, STEELCUT TRIO, SUNNIVA



PL210-1

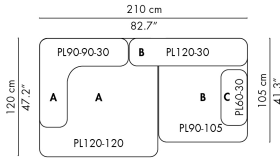

PL210-2

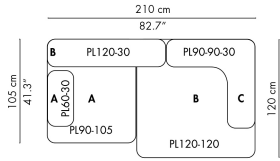

PL210-3

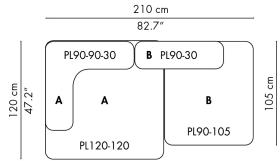

PL210-4

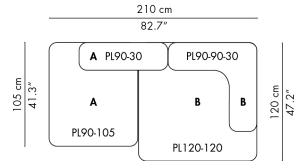

PL240-1

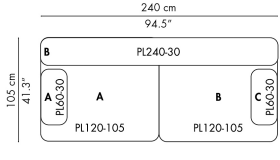

PL240-2

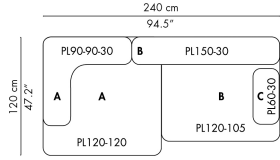

PL240-3

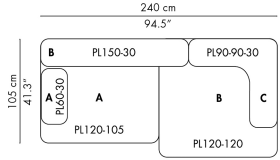

PL240-4

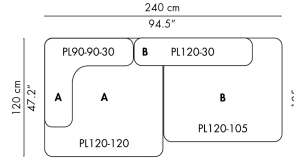

PL240-5

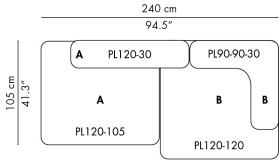

PL255-1

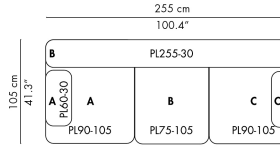

PL270-1

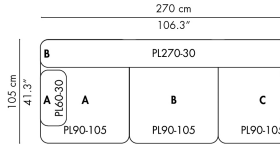

PL300-1

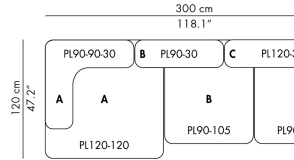

PL300-2

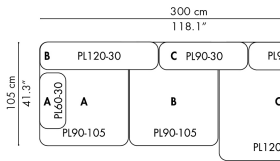

PL300-3

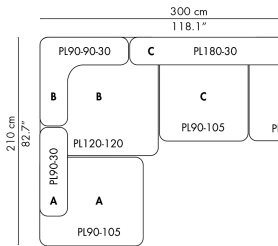

PL300-4

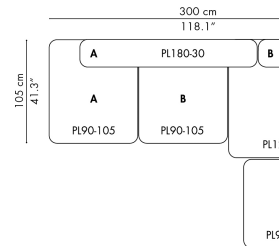

PL75-105

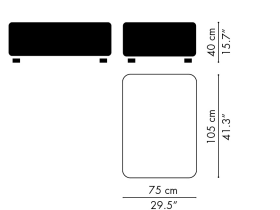

PL90-105

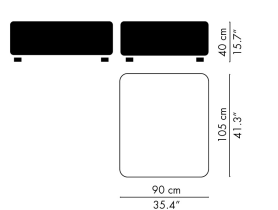

PL120-105

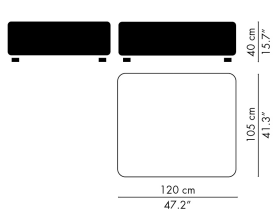

PL120-120

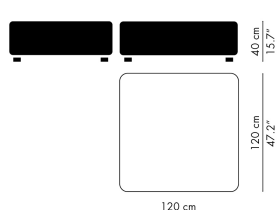

PL90-90-30

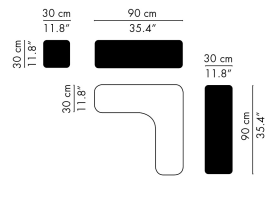

PL75-30

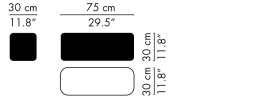

PL90-30

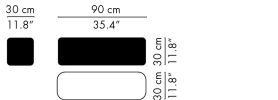

PL120-30

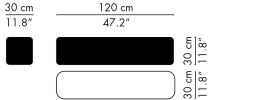

PL150-30

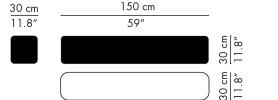

PL180-30

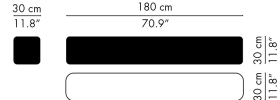

PL240-30

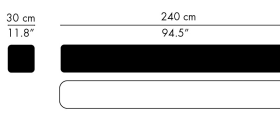

PL255-30

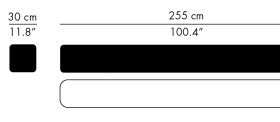

PL270-30

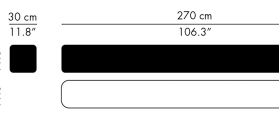

PL60-30

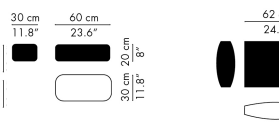

PL001

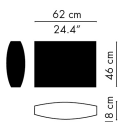



**FAVN™**  
**JAIME HAYON 2011**

**01.2023**

The Favn™ sofa comes in a wide range of textiles. It is available with a single coherent textile or a mix of up to three textiles; one textile for the shell and base, a second for the seat and back cushions and third textile for the small decorative cushions. The inner shell of the sofa is made of a hard moulded foam, padded with a soft, comfort-enhancing foam structure. The legs are made of brushed aluminium and a set of felt glides (for soft wooden floors) comes with the sofa as a standard.

MODEL	DESCRIPTION	CHRISTIANSHAVN	CATEGORY 1	CATEGORY 2
JH3	3-seater sofa, brushed aluminium legs incl. 2 loose decorative cushions	8.271	8.707	8.707

**OPTIONS**

MODEL	DESCRIPTION	CHRISTIANSHAVN	CATEGORY 1	CATEGORY 2
JH9	Additional decorative sofa cushion (1 pcs.)	225	237	237

CATEGORY 1: CANVAS (ONLY SEAT/BACK & DECORATIVE CUSHIONS), CAPTURE, DIABLO (ONLY SEAT/BACK & DECORATIVE CUSHIONS), FAME, REMIX (ONLY SEAT/BACK & DECORATIVE CUSHIONS), TONUS  
 CATEGORY 2: DIVINA, DIVINA MELANGE, DIVINA MD, FIORD, HALLINGDAL, RE-WOOL, STEELCUT, STEELCUT TRIO, SUNNIVA

**JH3**

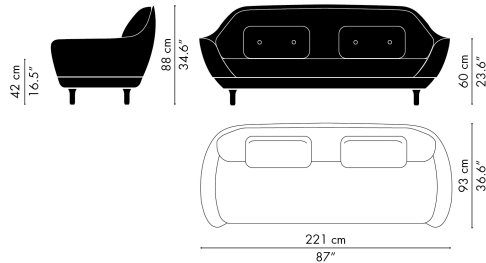

**JH9**

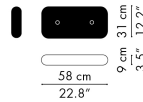



Lune™ is a modular sofa available in nine standard configurations featuring six different modules. The various modules can also be individually combined to create customised configurations. Lune™ comes fully upholstered in a variety of textiles and leather types. The base is available in brushed aluminium, clear lacquered oak or black coloured oak.

MODEL	DESCRIPTION	CHRISTIANSHAVN	CATEGORY 1	CATEGORY 2	CATEGORY 4	CATEGORY 5
JH200	Sofa, 2-seater, wooden or aluminium base	3.644	3.836	4.254	8.369	11.158
JH300	Sofa, 3-seater, wooden or aluminium base	5.101	5.370	5.928	11.158	15.343
JH301	Sofa, 3-seater with left chaise longue, wooden or aluminium base	5.896	6.207	6.904	12.135	17.017
JH302	Sofa, 3-seater with right chaise longue, wooden or aluminium base	5.896	6.207	6.904	12.135	17.017
JH400	Sofa, 4-seater, wooden or aluminium base	6.559	6.904	7.602	13.948	19.527
JH500	Sofa, 5-seater, wooden or aluminium base	8.017	8.439	9.276	16.737	23.711
JH510	Sofa, 5-seater with corner, wooden or aluminium base	9.474	9.973	10.949	18.830	27.896
JH600	Sofa, 6-seater, wooden or aluminium base	10.269	10.810	11.786	19.527	29.291
JH610	Sofa, 6-seater with corner, wooden or aluminium base	11.064	11.646	12.902	21.619	32.080

#### SOFA MODULES

MODEL	DESCRIPTION	CHRISTIANSHAVN	CATEGORY 1	CATEGORY 2	CATEGORY 4	CATEGORY 5
JH001	Sofa central module, wooden or aluminium base	1.656	1.744	1.953	3.208	4.603
JH002L	Sofa arm module left, wooden or aluminium base	1.921	2.022	2.232	3.905	5.579
JH002R	Sofa arm module right, wooden or aluminium base	1.921	2.022	2.232	3.905	5.579
JH003	Sofa corner module, wooden or aluminium base	2.584	2.720	2.929	4.882	6.974
JH004L	Sofa chaise longue module left, wooden or aluminium base	2.584	2.720	2.929	5.161	7.253
JH004R	Sofa chaise longue module right, wooden or aluminium base	2.584	2.720	2.929	5.161	7.253

CATEGORY 1: CANVAS, CAPTURE, DIABLO, FAME, LINARA, REMIX, TONUS  
 CATEGORY 2: DIVINA, DIVINA MELANGE, DIVINA MD, FIORD, HALLINGDAL, RE-WOOL, STEELCUT, STEELCUT TRIO, SUNNIVA  
 CATEGORY 4: AURA, SOFT  
 CATEGORY 5: EMBRACE

BASE COLOURS  
 BRUSHED ALUMINIUM, CLEAR LACQUERED OAK, BLACK COLOURED OAK

SELECTED TEXTILE COLOURS - SEE THE SURFACE SELECTION  
 LINARA (2494/198, 2494/324, 2494/118, 2494/340, 2494/30, 2494/237)





JH200

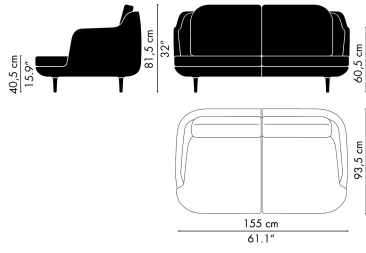

JH300

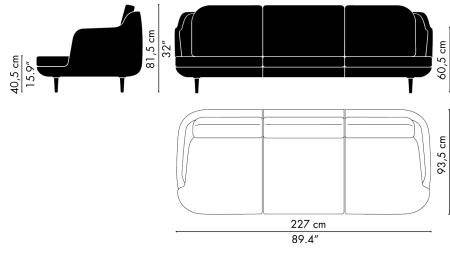

JH301

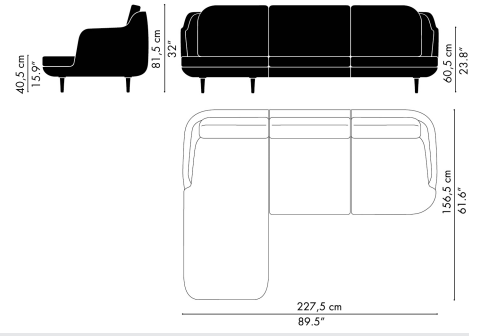

JH302

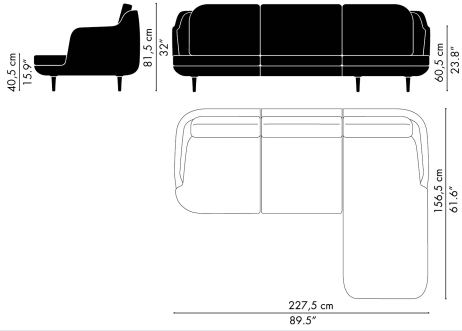

JH400

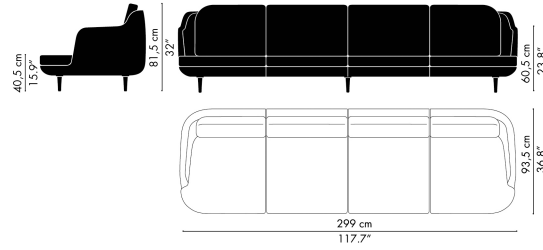

JH500

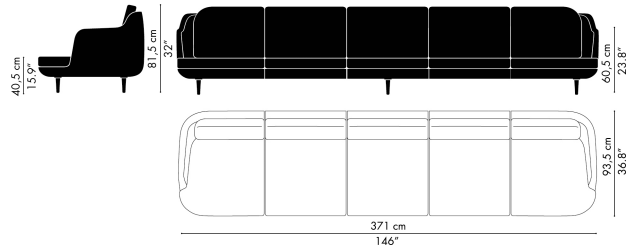

JH600

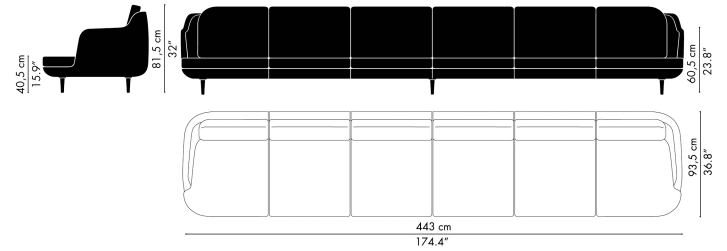

JH510

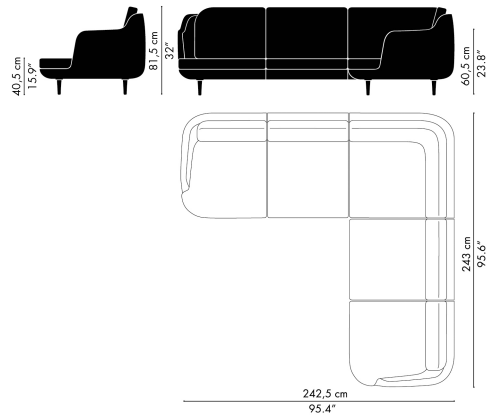

JH610

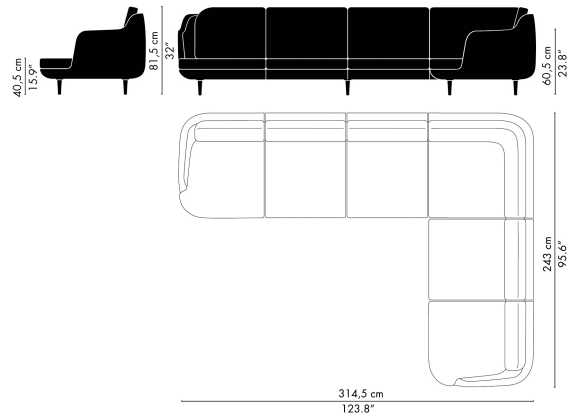

JH001

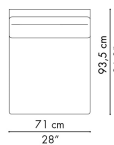

JH002L

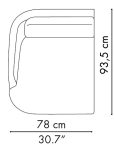

JH002R

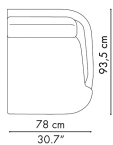

JH003

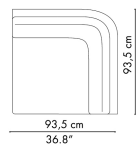

JH004L

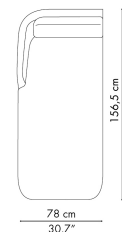

JH004R

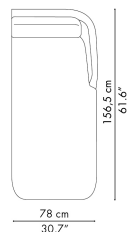



**RO™ SOFA**  
**JAIME HAYON 2017**

01.2023

The Ro™ Sofa comes fully upholstered in a wide range of textiles. As a single textile or a mix of two textiles; one textile for the shell and one for the cushions. The base consists of four legs in brushed aluminium or is available wooden base in solid oak with a clear lacquer finish.

MODEL	DESCRIPTION	CHRISTIANSHAVN	CATEGORY 1	CATEGORY 2
JH110	2-seater sofa, brushed aluminium legs	5.168	5.440	5.440
JH120	2-seater sofa, solid oak base	5.565	5.858	5.858

CATEGORY 1: CANVAS (ONLY CUSHIONS), CAPTURE, DIABLO (ONLY CUSHIONS), FAME, REMIX (ONLY CUSHIONS), TONUS  
 CATEGORY 2: DIVINA, DIVINA MELANGE, DIVINA MD, FIORD, HALLINGDAL, RE-WOOL, STEELCUT, STEELCUT TRIO, SUNNIVA

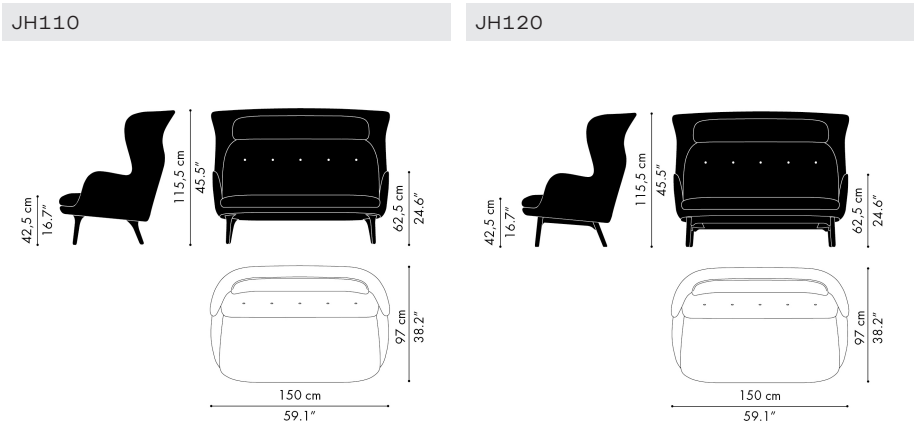



**PLENUM™**  
JAIME HAYON 2018

01.2023

Plenum™ is a high-back sofa system available as a one-, two- or three-seater. It offers features such as power plug and mounted side tables. Two table variants are also available.

**SOFAS**

MODEL	DESCRIPTION	CHRISTIANSHAVN	CATEGORY 1	CATEGORY 2
JH1001	One seater sofa, black powder coated steel base	4.686	4.933	5.381
JH1002	Two seater sofa, black powder coated steel base	6.106	6.428	6.876
JH1003	Three seater sofa, black powder coated steel base	7.242	7.624	8.072

CATEGORY 1: CANVAS, CAPTURE, FAME, REMIX, TONUS, MESSENGER  
CATEGORY 2: DIVINA, DIVINA MELANGE, DIVINA MD, FIORD, HALLINGDAL, RE-WOOL, STEELCUT, STEELCUT TRIO

**TABLES**

MODEL	DESCRIPTION	LAMINATE
JH70	Side sofa table, light grey laminate, black base	748
JH75	Coffee table, light grey laminate, black base	897
JH80	Table, light grey laminate, black base	1.046

JH70 MUST BE ORDERED TOGETHER WITH SOFA AND IS NOT INTERCHANGEABLE

**OPTIONS**

MODEL	DESCRIPTION	PRICE
PU01	Power unit for sofa, black (1 pcs., available in select markets only)	342

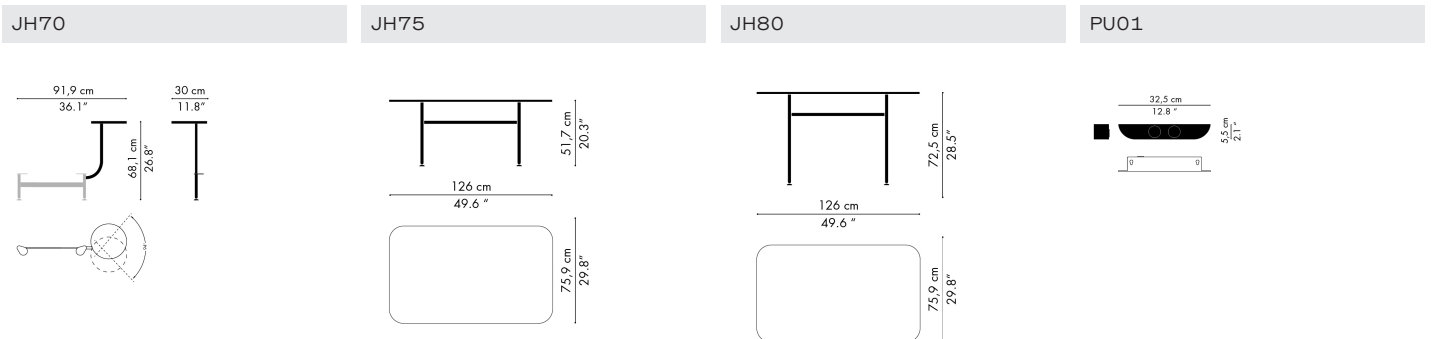
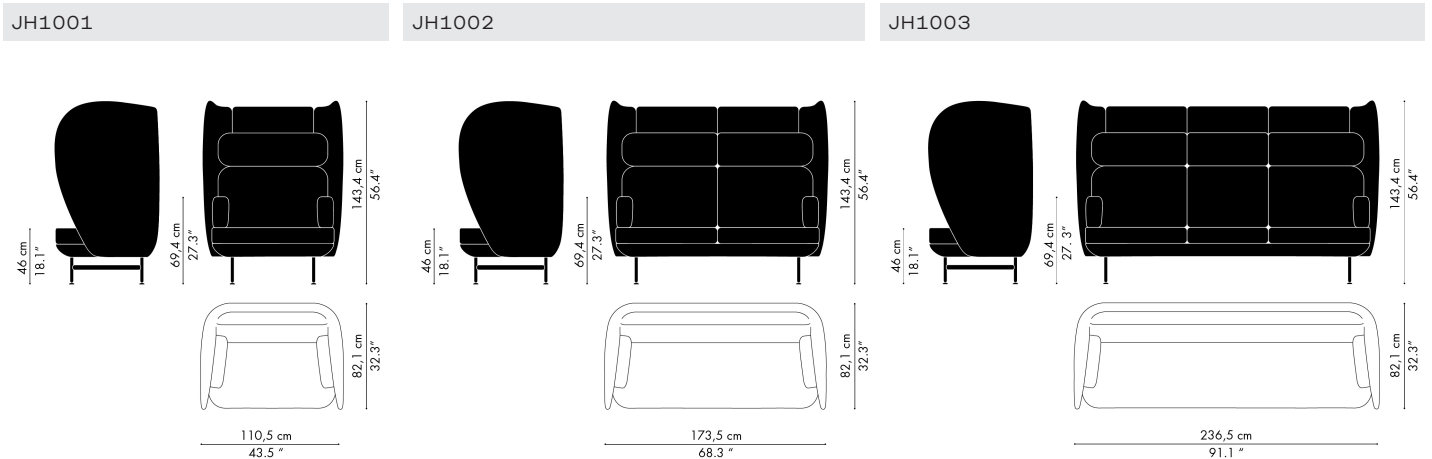



**SUPERELLIPSE™**  
**PIET HEIN/BRUNO MATHSSON 1968**

01.2023

The Superellipse™ tables are available in various sizes and with a tabletop made of either laminate or walnut veneer. While laminate versions come with an aluminium edge, the walnut veneer versions come with a natural wooden edge. The table's iconic span legs are available either in chromed or powder coated steel.

**DINING TABLES (HEIGHT 72 CM)**

MODEL	DESCRIPTION	LAMINATE	VEENER: WALNUT	H/L/W
B611	Table, span legs, detachable	1.707	2.465	72/135/90
B612	Table, span legs, detachable	1.849	2.616	72/150/100
B616	Table, span legs, detachable	1.991	2.893	72/170/100
B613	Table, span legs, detachable	2.133	3.237	72/180/120
B614	Table, span legs, detachable	2.844	4.289	72/240/120
B617	Table, span legs, detachable	4.410	6.646	72/300/130

**OPTIONS**

DESCRIPTION	PRICE
Span legs, table height 52 cm (B2), 70 cm (B4) or 74 cm (B8)	84

LAMINATE COLOURS - SEE THE SURFACE SELECTION  
 WHITE (032), GREY (718), BLACK (720), BROWN OTTAWA (717), GREY BROMO (724), GREY EFESO (725)

SPAN LEGS COLOURS  
 SILVER GREY (170), WARM GRAPHITE (180), BROWN BRONZE (390), BLACK (190), WHITE (100), NINE GREY (150), CHROME

**B611**

90 X 135 CM | 76 CM |

72 cm 28.3"  
90 cm 35.4"  
135 cm 53.1"

**B612**

100 X 150 CM | 92 CM |

72 cm 28.3"  
100 cm 39.4"  
150 cm 59.1"

**B616**

100 X 170 CM | 99 CM |

72 cm 28.3"  
100 cm 39.4"  
170 cm 66.9"

**B613**

120 X 180 CM | 99 CM |

72 cm 28.3"  
120 cm 47.2"  
180 cm 70.8"

**B614**

120 X 240 CM | 144 CM |

72 cm 28.3"  
120 cm 47.2"  
240 cm 94.5"

**B617**

130 X 300 CM | 187 CM |

72 cm 28.3"  
130 cm 51.2"  
300 cm 118.1"

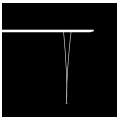

**EXTENSION TABLES (HEIGHT 72 CM)**

MODEL	DESCRIPTION	LAMINATE	VENEER: WALNUT	H/L/W
B620	Table, span legs, detachable	3.983	6.368	72/170(270)/100
B619	Table, span legs, detachable	4.267	7.047	72/180(300)/120

**OPTIONS**

DESCRIPTION	PRICE
Span legs, table height 52 cm (B2), 70 cm (B4) or 74 cm (B8)	84

LAMINATE COLOURS - SEE THE SURFACE SELECTION  
WHITE (032), GREY (718), BLACK (720), BROWN OTTAWA (717), GREY BROMO (724), GREY EFESO (725)

SPAN LEGS COLOURS  
SILVER GREY (170), WARM GRAPHITE (180), BROWN BRONZE (390), BLACK (190), WHITE (100), NINE GREY (150), CHROME

**B620**

100 X 170/270 CM

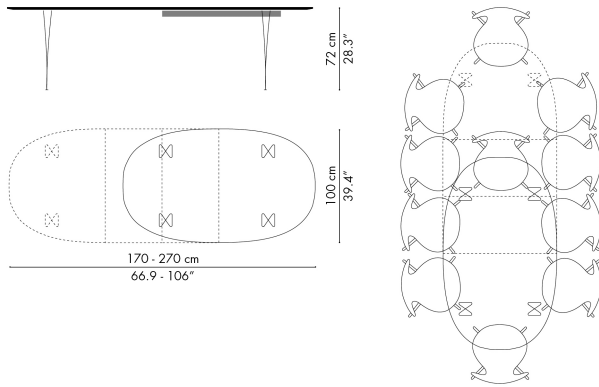

**B619**

120 X 180/300 CM

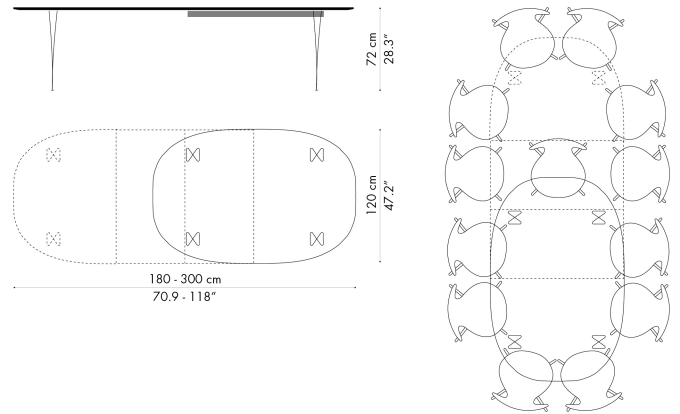



The Supercircular™ tables are available in various sizes and with a tabletop made of either laminate or walnut veneer. While laminate versions come with an aluminium edge, the walnut veneer versions come with a natural wooden edge. The four-star base is made of either satin polished aluminium with a satin chromed steel pedestal or powder coated aluminium with matching steel pedestal. One table configuration is also available with the iconic span legs that come either in chromed or powder coated steel. The Supercircular™ tables are also configurable as coffee or bar table.

**DINING TABLES (HEIGHT 72 CM)**

MODEL	DESCRIPTION	LAMINATE	VENEER: WALNUT	H/L/W
A602	Table (Ø:75 cm), pedestal base, 4-star	1.298	1.818	72/75/75
A603	Table (Ø:100 cm), pedestal base, 4-star	1.564	2.143	72/100/100
B603	Table (Ø:100 cm), span legs, detachable	1.635	2.268	72/100/100

**COFFEE TABLES (HEIGHT 47 CM)**

MODEL	DESCRIPTION	LAMINATE	VENEER: WALNUT	H/L/W
A202	Coffee table (Ø:75 cm), pedestal base, 4-star	1.209	1.655	47/75/75
A203	Coffee table (Ø:100 cm), pedestal base, 4-star	1.422	1.980	47/100/100

**BAR TABLE (HEIGHT 108 CM)**

MODEL	DESCRIPTION	LAMINATE	VENEER: WALNUT	H/L/W
A902	Bar table (Ø:75 cm), pedestal base, 4-star	1.419	1.932	108/75/75

**OPTIONS**

DESCRIPTION	PRICE
Pedestal base 4-star, table height 47 cm (A2), 70 cm (A4), Table height 108 cm (A9 - only for Ø 75 cm table top)	82
Span legs, table height 52 cm (B2), 70 cm (B4) or 74 cm (B8)	84

LAMINATE COLOURS - SEE THE SURFACE SELECTION  
WHITE (032), GREY (718), BLACK (720), BROWN OTTAWA (717), GREY BROMO (724), GREY EFESO (725)

PEDESTAL BASE COLOURS  
SILVER GREY (170), WARM GRAPHITE (180), BROWN BRONZE (390), BLACK (190), SATIN POLISHED ALUMINIUM

SPAN LEGS COLOURS  
SILVER GREY (170), WARM GRAPHITE (180), BROWN BRONZE (390), BLACK (190), WHITE (100), NINE GREY (150), CHROME

A602	A603	B603
<p>75 X 75 CM</p>	<p>100 X 100 CM</p>	<p>100 X 100 CM   51 CM  </p>
A202	A203	A902
		<p>H: 108 CM</p>



The Circular tables are available in various sizes and with a tabletop made of either laminate or walnut veneer. While laminate versions come with an aluminium edge, the walnut veneer versions come with a natural wooden edge. The four-star base is made of either satin polished aluminium with a satin chromed steel pedestal or powder coated aluminium with matching steel pedestal. The Circular tables are also configurable as coffee or bar table.

**DINING TABLES (HEIGHT 72 CM)**

MODEL	DESCRIPTION	LAMINATE	VENEER: WALNUT	H/Ø
A622	Table, pedestal base, 4-star	1.280	1.663	72/75
A623	Table, pedestal base, 4-star	1.493	1.943	72/90
A825	Table, pedestal base, 6-star	2.204	2.965	72/120
A826	Table, pedestal base, 6-star	2.916	3.446	72/145

**COFFEE TABLES (HEIGHT 47 CM)**

MODEL	DESCRIPTION	LAMINATE	VENEER: WALNUT	H/Ø
A222	Coffee table, pedestal base, 4-star	1.137	1.500	47/75
A223	Coffee table, pedestal base, 4-star	1.351	1.780	47/90

**BAR TABLE (HEIGHT 108 CM)**

MODEL	DESCRIPTION	LAMINATE	VENEER: WALNUT	H/Ø
A922	Bar table, pedestal base, 4-star	1.411	1.777	108/75

**OPTIONS**

DESCRIPTION	PRICE
Pedestal base 4-star, table height 47 cm (A2), 70 cm (A4), Table height 108 cm (A9 - only for Ø 75 cm table top)	82
Pedestal base 6-star, table height 70 cm (A8)	82

**LAMINATE COLOURS - SEE THE SURFACE SELECTION**  
WHITE (032), GREY (718), BLACK (720), BROWN OTTAWA (717), GREY BROMO (724), GREY EFESO (725)

**PEDESTAL BASE COLOURS**  
SILVER GREY (170), WARM GRAPHITE (180), BROWN BRONZE (390), BLACK (190), SATIN POLISHED ALUMINIUM

**A922**

H: 108 CM

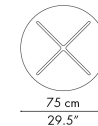

**A622**

Ø 75 CM

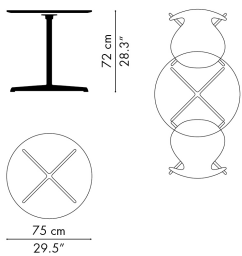

**A623**

Ø 90 CM

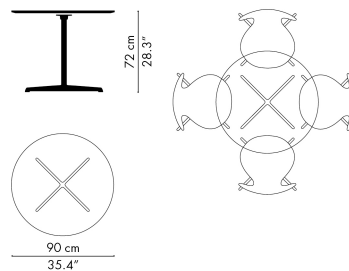

**A222**

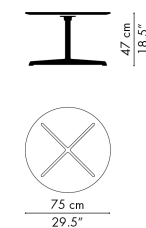

**A825**

Ø 120 CM

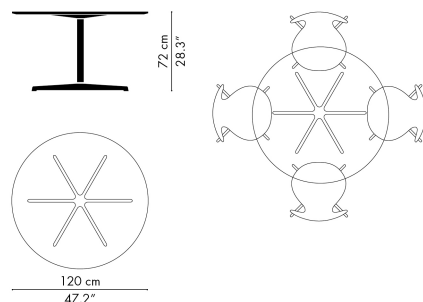

**A826**

Ø 145 CM

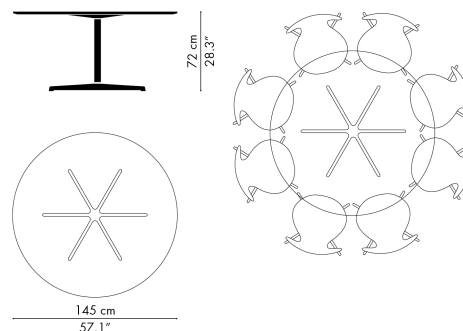

**A223**

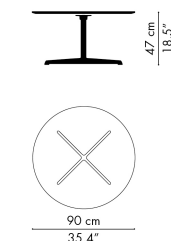

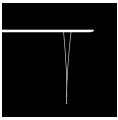

## RECTANGULAR PIET HEIN/BRUNO MATHSSON/ARNE JACOBSEN 1968

01.2023

The Rectangular tables are available in two sizes and with a tabletop made of either laminate or walnut veneer. While laminate versions come with an aluminium edge, the walnut veneer versions come with a natural wooden edge. The table's iconic span legs are available either in chromed or powder coated steel.

### DINING TABLES (HEIGHT 72 CM)

MODEL	DESCRIPTION	LAMINATE	VENEER: WALNUT	H/L/W
B637	Table, span legs, detachable	1.707	2.548	72/140/80
B638	Table, span legs, detachable	1.920	2.690	72/160/80

### OPTIONS

DESCRIPTION	PRICE
Span legs, table height 52 cm (B2), 70 cm (B4) or 74 cm (B8)	84

#### LAMINATE COLOURS - SEE THE SURFACE SELECTION

WHITE (032), GREY (718), BLACK (720), BROWN OTTAWA (717), GREY BROMO (724), GREY EFESO (725)

#### SPAN LEGS COLOURS

SILVER GREY (170), WARM GRAPHITE (180), BROWN BRONZE (390), BLACK (190), WHITE (100), NINE GREY (150), CHROME

#### B637

80 X 140 CM | 112 CM |

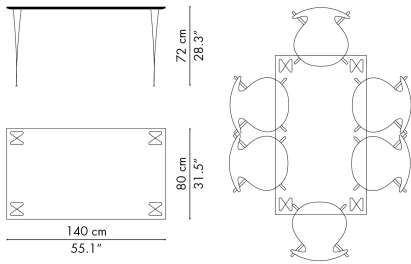

#### B638

80 X 160 CM | 121 CM |

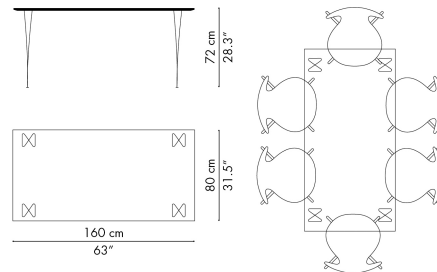





**FH3605™**  
ARNE JACOBSEN 1955

01.2023

The FH3605™ table or "Writing Desk" is a rectangular table available in either black coloured ash or walnut veneer. The base consists of four legs made of chromed or black powder coated steel with a solid wood detail matching the tabletop. FH3605™ is available with one document drawer in solid wood in walnut or black coloured ash. The drawer can be installed in either left or right side.

MODEL	DESCRIPTION	BLACK COLOURED ASH	WALNUT	H/L/W
FH3605DD	Desk with drawer, veneer table top, chromed or powder coated steel, table height 72 cm or 74 cm	2.506	2.734	72/152/80
FH3605DE	Desk, veneer table top, chromed or powder coated steel, table height 72 cm or 74 cm	2.050	2.278	72/152/80
FH3605DR	Drawer, solid wood	455	512	8/52/30

FH3605DD      FH3605DE      FH3605DR

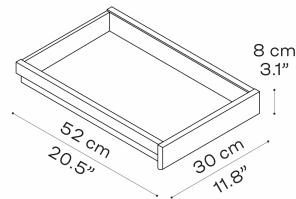
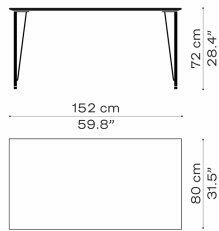
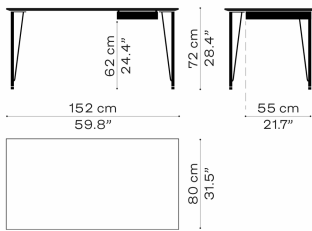

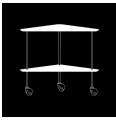

**AJ TROLLEY**  
ARNE JACOBSEN 1955/2020

01.2023

The AJ Trolley is a small table with triangular tabletops with a black coloured ash veneer finish. While the tabletops are made of veneered medium-density fiberboard, the frame is made of brushed stainless steel and comes with castors with a metal housing.

MODEL	DESCRIPTION	COLOURED ASH	H/L/W
840410	Trolley, black coloured ash, brushed stainless steel	665	54,7/57/59

840410

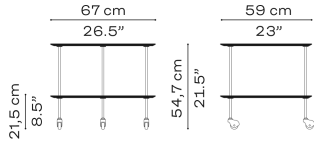



## STUB METTE SCHELDE 2020

01.2023

The Stub™ is a side table with a tempered glass tabletop moulded around a wooden base. The base is made of pressure moulded veneer base and comes in three different finishes: Lacquered oak, lacquered ash or black coloured ash. The integrated, tempered glass tabletop is cut for a smooth transition from glass to wood on the table surface.

MODEL	DESCRIPTION	VENEER	H/Ø
MS11	Side table, lacquered oak, lacquered ash or black coloured ash, glass	533	44,5/49

MS11

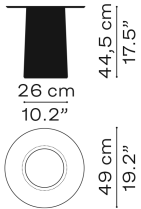



The Essay™ table comes in three sizes and is made of solid oak which is treated with either natural or white pigmented oil. The Essay™ extension leaf comes in two widths and is available in black laminate.

MODEL	DESCRIPTION	NATURAL OAK	WHITE PIGMENTED OAK	H/L/W
CM21	Table, solid oak	3.792	3.792	72/218/95
CM27	Table, solid oak	5.057	5.057	72/272/100
CM31	Table, solid oak	6.321	6.321	72/317/100

**SURFACE OPTIONS**  
CLEAR OILED OAK (175), WHITE PIGMENTED OAK (170)

**EXTENSION LEAF**

MODEL	DESCRIPTION	BLACK LAMINATE	L/W
CM95	Extension leaf, black laminate tabletop	583	48/95
CM100	Extension leaf, black laminate tabletop	583	48/100

**CM21**

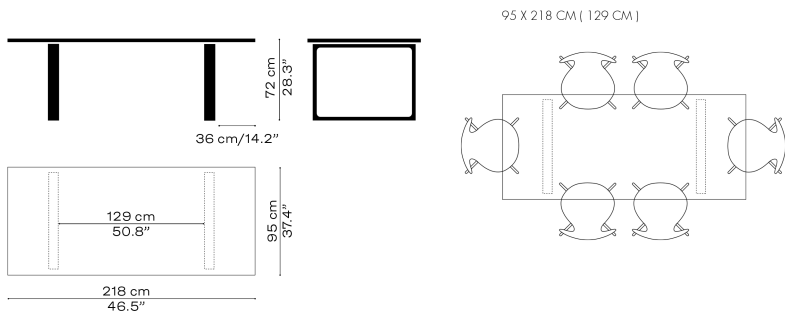

**CM21 + 2/CM95**

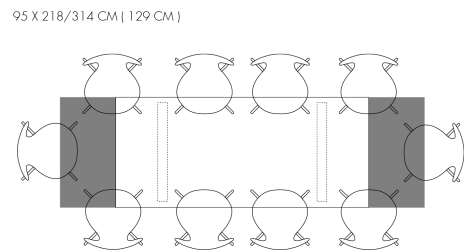

**CM27**

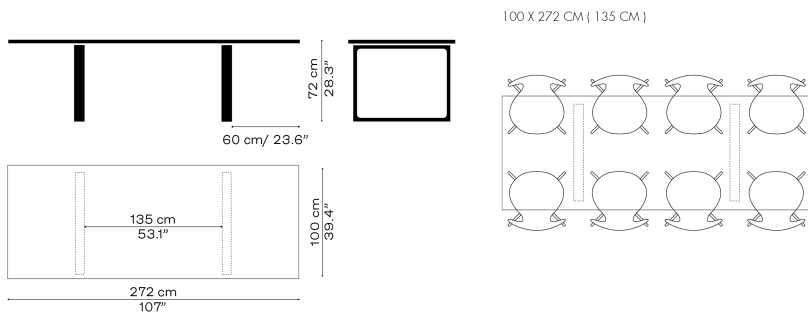

**CM27 + 2/CM100**

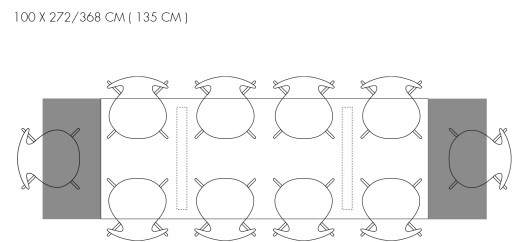



CM31

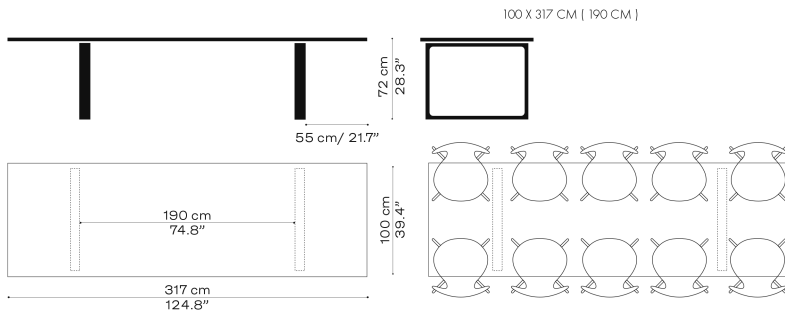

CM31 + 2/CM100

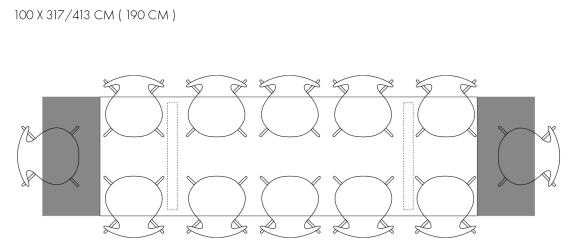

CM95

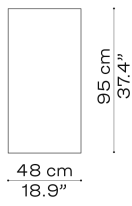

CM100

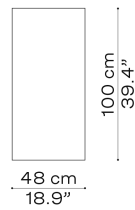



The Analog™ table comes in three sizes with a tabletop in either white laminate, oak or walnut veneer. The base consists of four legs made of solid wood, which can be configured in either oak, black lacquered oak or walnut. The legs are attached to the table top with a 'trumpet' in either white or black powder coated aluminium. The underside of the table top is lacquered in colours matching the trumpet.

MODEL	DESCRIPTION	LAMINATE: WHITE	VENEER: OAK, WALNUT	H/L/W
JH43	Table, laminate or veneer top, legs in solid wood	1.426	1.652	72/130/105
JH63	Table, laminate or veneer top, legs in solid wood	1.652	2.102	72/185/105
JH83	Table, laminate or veneer top, legs in solid wood	2.027	2.628	72/245/105

COLOURS - SEE THE SURFACE SELECTION	BASE: BLACK TRUMPET/ BLACK LACQUERED OAK	BASE: WHITE TRUMPET/ OAK	BASE: BLACK TRUMPET/ WALNUT
TABLETOP: WHITE		•	
TABLETOP: OAK		•	
TABLETOP: WALNUT	•		•

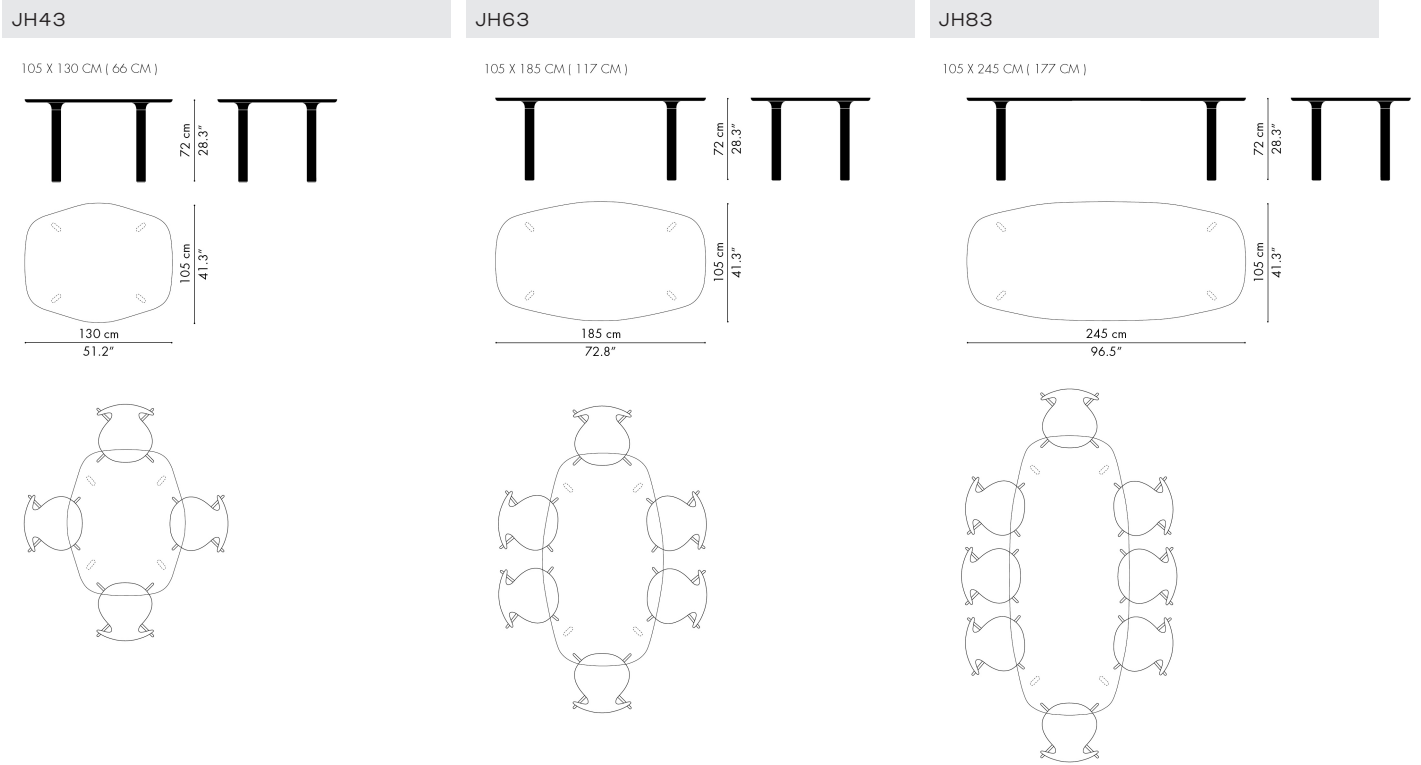



The Join™ coffee table series comes in three shapes. The table top is made of solid oak and configurable in two finishes: Oak with clear lacquer or black coloured oak. The base consists of four legs in black powder coated steel.

MODEL	DESCRIPTION	OAK(171) BLACK COLOURED OAK	H/L/W
FH21	Coffee table, oval, solid wood, powder coated steel legs	515	37/76/47
FH41	Coffee table, round, solid wood, powder coated steel legs	663	37/ø80
FH61	Coffee table, oval, solid wood, powder coated steel legs	736	37/130/50

FH21

47 X 76 CM

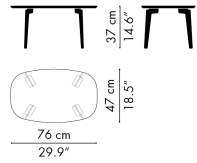

FH41

Ø80 X 37 CM

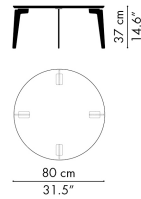

FH61

50 X 130 CM

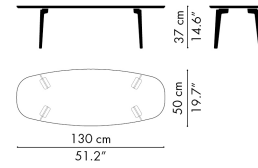



**PLURALIS™**  
KASPER SALTO 2016

01.2023

The Pluralis™ table comes in a wide range of sizes and with five different table tops: Mauve Brown linoleum, Lava Grey or white laminate and oak or walnut veneer. The base is made of die-cast aluminium and comes with a polished or powder coated finish. The base is mounted with adjustable glides. Electrification and cable management are optionally available.\*

MODEL	DESCRIPTION	LAMINATE	LINOLEUM	OAK VENEER	WALNUT VENEER
KS420	Table, polished or powder coated aluminium, 80 cm x 160 cm	1.554	1.864	2.419	2.464
KS421	Table, polished or powder coated aluminium, 80 cm, 90 cm, or 100 cm x 200 cm	1.920	2.309	2.997	3.052
KS422	Table, polished or powder coated aluminium, 80 cm, 90 cm, 100 cm or 120 cm x 240 cm	2.331	2.797	3.640	3.718
KS423	Table, polished or powder coated aluminium, 90 cm, 100 cm or 120 cm x 320 cm	3.108	3.729	4.850	4.950
KS424	Table, polished or powder coated aluminium, 90 cm, 100 cm or 120 cm x 480 cm	4.662	5.594	7.269	7.414
KS425	Table, polished or powder coated aluminium, 90 cm, 100 cm or 120 cm x 720 cm	6.659	7.991	10.389	10.599

**OVERHANG**

One end (25cm)	250	300	388	400
Both ends (2x25cm=50cm)	444	533	688	699

LAMINATE COLOURS: WHITE (122), LAVA GREY (152)

LINOLEUM COLOURS: MAUVE BROWN (361)

BASE COLOURS: WARM GRAPHITE (180), BROWN BRONZE (390), BLACK (190), POLISHED ALUMINIUM

**ELECTRIFICATION**

PRICE

Power Frame, including 4-module power strip, 28,4 cm x 7,3 cm, stainless steel	443
Top Frame including 4-module power strip, 30,3 cm x 9,4 cm, with lid matching the tabletop	1.332
Cut out for customer's own electrification solution	111
Rectangular cable well, L 32,5 cm x W 13 cm, incl. cut out, aluminium (1 pcs.)	202
Round cable well, Ø 8,8 cm, incl. cut out, aluminium (1 pcs)	202
Cable tray, 65 cm, black powder coated steel	168
Cable hose, 78-125 cm, black or silver	168

\*POWER FRAME AND TOP FRAME AVAILABLE IN EU, GB, CH, KR, JP, AND CN

KS420

KS421

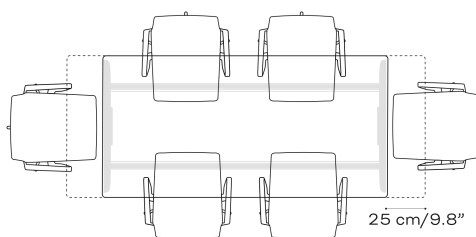
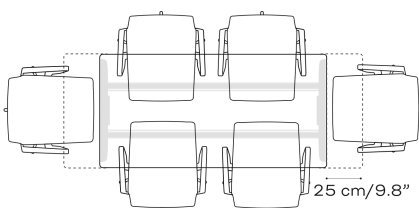
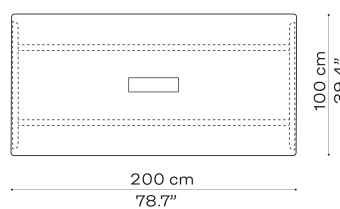
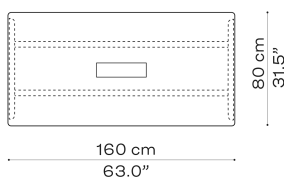





KS422

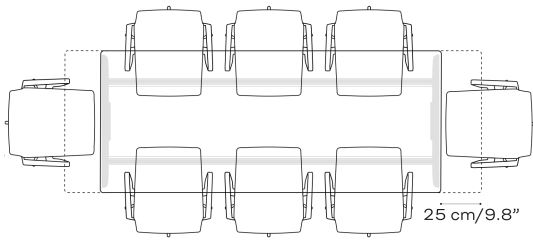
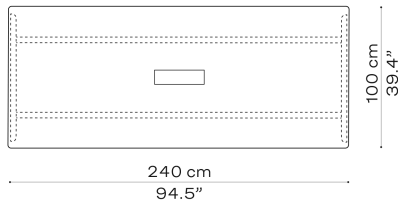

KS423

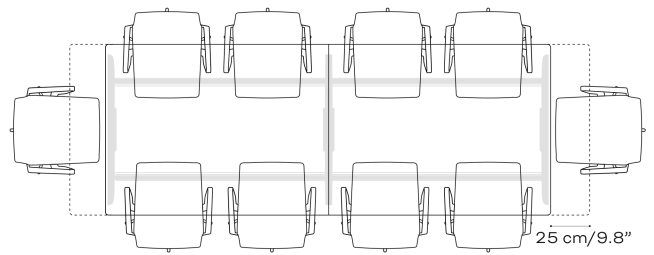
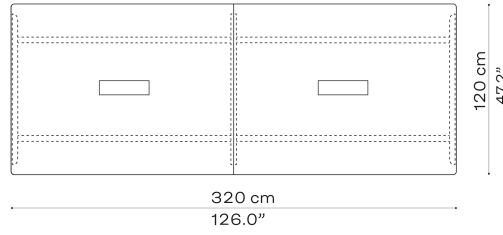

KS424

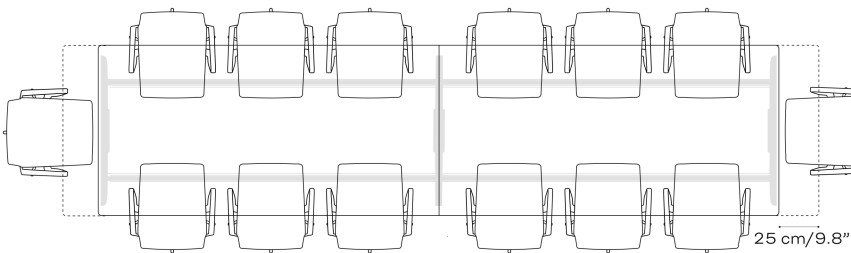
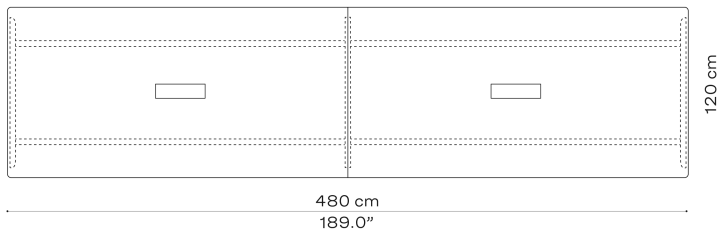



KS425

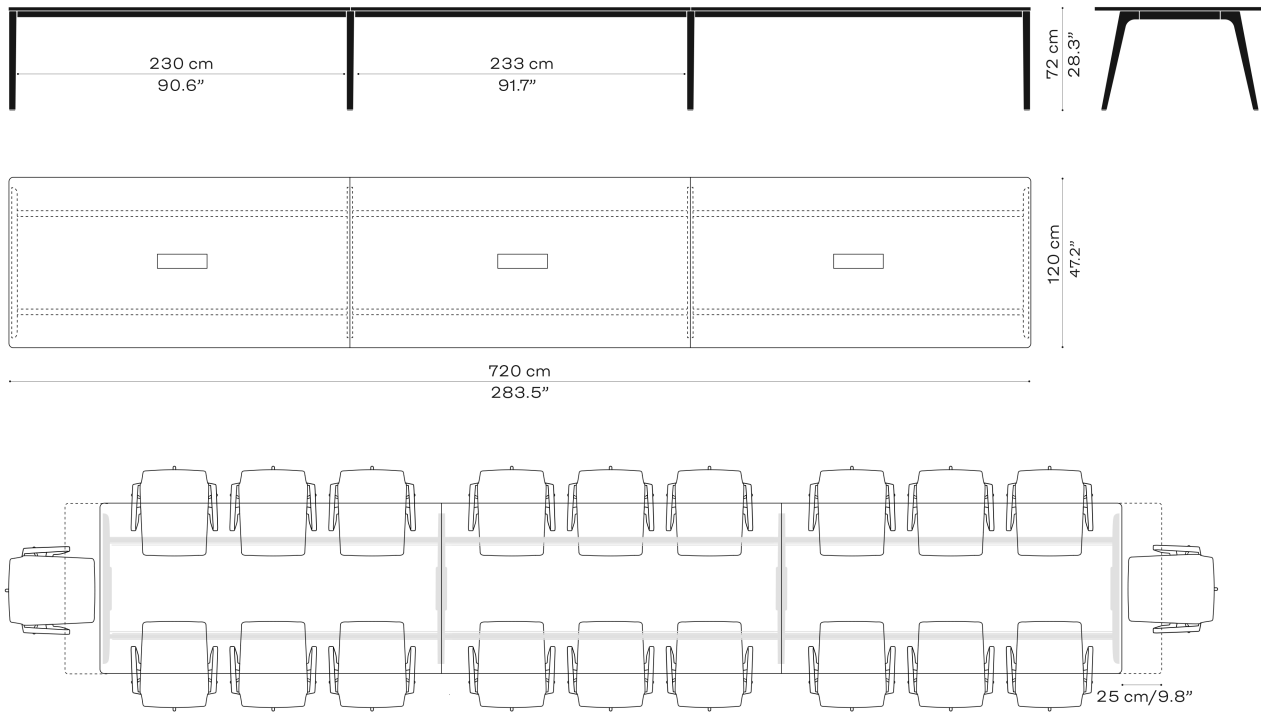

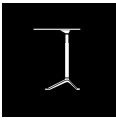

**LITTLE FRIEND™**  
**KASPER SALTO 2005**

01.2023

The Little Friend™ table is available as a height-adjustable or fixed height version. The table top comes in compact laminate with four different finishes: Black laminate, white laminate, oak or walnut veneer. The base is made of a die-cast aluminum foot that is connected to a steel column. The configurable base finishes in chrome column/polished foot, white lacquered or black lacquered depend on the table top.

MODEL	DESCRIPTION	LAMINATE: BLACK, WHITE	VENEER: OAK, WALNUT	H/Ø
KS11	Table, height adjustable, chromed/polished or lacquered base	1.081	1.200	50 - 73/45
KS12	Table, fixed height, chromed/polished or lacquered base	731	811	60/45

COLOURS - SEE THE SURFACE SELECTION	TABLETOP: WHITE	TABLETOP: BLACK	TABLETOP: OAK	TABLETOP: WALNUT
BASE: CHROMED/POLISHED	•	•	•	•
BASE: WHITE	•			
BASE: BLACK		•	•	•

KS11

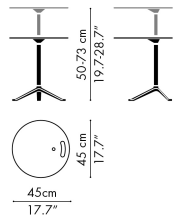

KS12

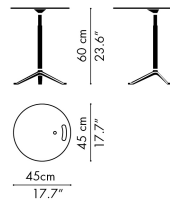



**PLANNER™ TABLE SERIES**  
**PAUL MCCOBB 1952/2018**

**01.2023**

The Planner™ Table Series consists of coffee tables in six different sizes. The marble tabletop is available in two colours: Cream or Charcoal. The base consists of a frame in black powder coated steel.

MODEL	DESCRIPTION	MARBLE	H/L/W
MC300	Circular coffee table, marble top, powder coated base	1.299	40/80/80
MC310	Rectangular coffee table, marble top, powder coated steel base	1.026	40/75/45
MC320	Square coffee table, marble top, powder coated steel base	1.299	40/80/80
MC330	Square coffee table, marble top, powder coated steel base	934	40/45/45
MC340	Square coffee table, marble top, powder coated steel base	2.001	40/100/100
MC350	Rectangular coffee table, marble top, powder coated steel base	1.801	40/130/70

MARBLE COLOURS - SEE THE SURFACE SELECTION  
 CREAM (120), CHARCOAL (220)

<p><b>MC300</b></p>	<p><b>MC310</b></p>	<p><b>MC320</b></p>
<p><b>MC330</b></p>	<p><b>MC340</b></p>	<p><b>MC350</b></p>



**EGG™ TABLE**  
**ARNE JACOBSEN 1952**

01.2023

The Egg™ Table is crafted with an FSC-certified walnut veneer tabletop. Resting on three chromed steel legs, the elliptical design is equally purposeful as a kitchen or dining table in smaller spaces as it is in a home office. It fits seamlessly into any setting.

MODEL	DESCRIPTION	WALNUT VENEER	H/L/W
3603	Table, 3 legs, chromed tubular steel	1.833	74/115/84

3603 H72

3603 H74

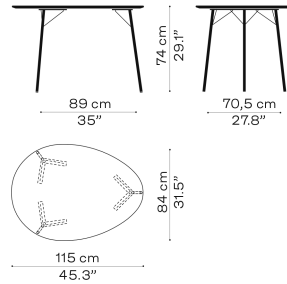
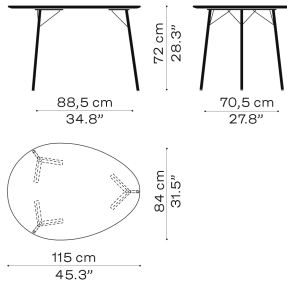

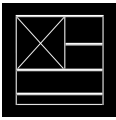

The Planner™ Shelving Series comes in three sizes with shelves in oak veneer and a black powder coated steel frame.

MODEL	DESCRIPTION	VENEER: OAK	H/L/W
MC500	Shelving, small, oak veneer, powder coated steel frame	1.133	84,4/120,7/38,1
MC510	Shelving, medium, oak veneer, powder coated steel frame	1.416	123,2/120,7/38,1
MC520	Shelving, large, oak veneer, powder coated steel frame	1.699	165/120,7/38,1

MC500

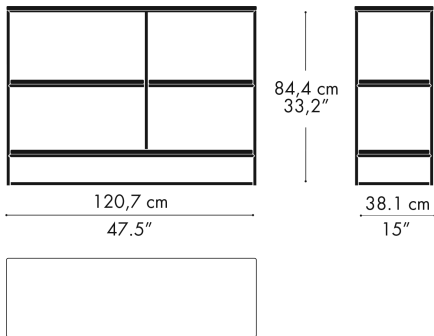

MC510

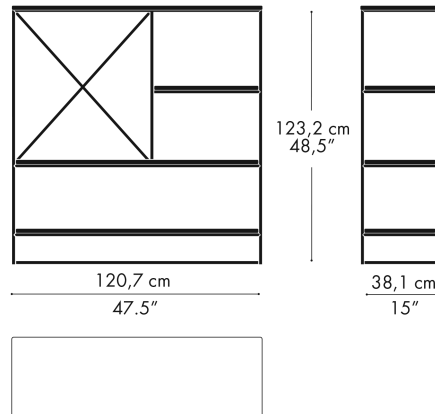

MC520

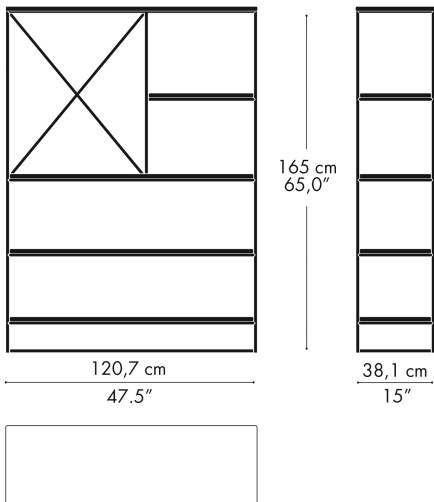

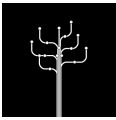

**COAT TREE™ / COAT TREE™ WALL**  
**SIDSE WERNER 1971/2019**

**01.2023**

The Coat Tree™ has a free standing and wall mounted variant consisting of eight or four bent steel tubes with round moulded plastic knobs.

MODEL	DESCRIPTION	CHROMED STEEL	POWDER COATED STEEL	H/L/W
840332	Coat Tree, Chrome / Black knobs	1.024		193/65
840330	Coat Hanger, Light Grey / Grey knobs		318	104/46/30
840331	Coat Hanger, Dark Blue / Black knobs		318	104/46/30

840332

840330/840331

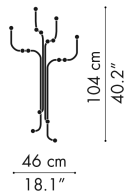
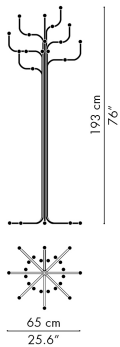



A selection of spare parts for chairs, lounge furniture and tables. Items are sold in colli unless stated otherwise.

**CHAIRS**

DESCRIPTION	PRICE
Ferrule for Ant™, Series 7™, Grand Prix™ and Lily™, black. 1 colli (24 pcs)	2
Ferrule w/felt for Ant™, Series 7™, Grand Prix™ and Lily™, black. 1 colli (24 pcs)	2
Ferrule for Grand Prix™ (4130) wooden base. 1 colli (24 pcs)	2
Ferrule w/felt for Grand Prix™ (4130), wooden base. 1 colli (24 pcs)	2
Hard castor for soft floors with alu cap for Series 7™, no brake	15
Soft castor for hard floors with alu cap for Series 7™, no brake	15
Hard castor for soft floors with alu cap and tap for Series 7™ produced before 2003, no brake	15
Soft castor for hard floors with alu cap and tap for Series 7™ produced before 2003, no brake	15
Hard castor for soft floors with alu cap for Oxford™, no brake	15
Soft castor for hard floors with alu cap for Oxford, no brake	15
Spacer for Ant™, Series 7™, Grand Prix™, Lily™, High Dot™ & Dot™, black or grey rubber. 1 colli (24 pcs)	2
Cover for Ant™, Series 7™, Grand Prix™, Lily™ & Dot™ (4-legs), black or grey plastic. 1 colli (6 pcs)	11
Cover for Ant™ & High Dot™ (3-legs), black or grey plastic. 1 colli (6 pcs)	11
Chair base 4 legs, seat height 43 cm, 46 cm or 48 cm, for Ant™, Series 7™ & Grand Prix™, chromed or powder coated steel	192

FERRULE / FERRULE W. FELT

SPACER

COVER



CHAIR BASE

CASTOR (SERIES 7™)

CASTOR (OXFORD™)



**LOUNGE & SOFAS**

DESCRIPTION	PRICE
Glider for the Egg™, Swan™ and Swan sofa™, moulded black polyamide. 1 colli (5 pcs)	2
Glider with felt for the Egg™, Swan™ and Swan sofa™, moulded black polyamide. 1 colli (5 pcs)	2
Adjustment handle for the Egg™, polished stainless steel	27

Alphabet™ covers are available for all modules at 35% of the module price

GLIDE

GLIDE W. FELT

ADJUSTMENT HANDLE

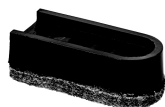





TABLES

DESCRIPTION

PRICE

Glide for span legs, transparent plastic. 1 colli (4 pcs)	6
Span legs (set of 4 pcs.), table height 70 cm (B4), without mounting plate, chromed or powder coated steel	690
Span legs (set of 4 pcs.), table height 72 cm (B6), without mounting plate, chromed or powder coated steel	690
Pedestal base 4-star, table height 47 cm (A2), satin polished aluminium, satin chromed pedestal	737
Pedestal base 4-star, table height 72 cm (A6), satin polished aluminium, satin chromed pedestal	737
Pedestal base, 6-star, table height 72 cm (A8), satin polished aluminium, satin chromed pedestal	1.542
Pedestal base, 4-star, table height 108 cm (A9), satin polished aluminium, satin chromed pedestal	849
Laminate cleaner for white laminate. (6 pcs)	97
Cleaning sponges for laminate tabletops (10 pcs)	9
Essay™ oil kit, natural or white pigmented (1 pcs)	66
Stonewash for marble tables (1 pcs)	32

SPAN LEGS

A2

A6

A8

A9

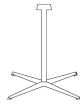

GLIDER SPAN LEGS

LAMINATE CLEANER

ESSAY OIL KIT

STONE WASH

CLEANING SPONGES



# SURFACE SELECTION

# SURFACE SELECTION

Colours and materials may vary from the images shown.

## TEXTILES

Please note that not all textiles are suitable on all the furniture. On each individual model the standard textile options are listed. Some textiles are only available in a selection of colours.

### CUSTOMER'S OWN MATERIAL (COM)

Customers can supply their own textiles. Textile requirements, based on standard textile 130 cm wide, can be given on inquiry. We reserve the right to reject textiles that we find unsuitable for upholstery.

### CATEGORY 1

#### BELFAST (VELVET)

MATERIALS: 100% COTTON  
DURABILITY: 50.000 MARTINDALE  
COLOURS: 10

#### CANVAS

MATERIALS: 90% NEW WOOL (WORSTED), 10% NYLON  
DURABILITY: 100.000 MARTINDALE  
AVAILABLE IN ALL COLOURS

#### CAPTURE

MATERIALS: 85% WOOL, 15% POLYAMIDE  
DURABILITY: 200.000 MARTINDALE  
AVAILABLE IN ALL COLOURS

#### DIABLO

MATERIALS: 54% VISCOSE, 46% COTTON  
DURABILITY: >30.000 MARTINDALE  
AVAILABLE IN ALL COLOURS

#### FAME

MATERIALS: 95% WOOL, 5% POLYAMID  
DURABILITY: 200.000 MARTINDALE  
AVAILABLE IN ALL COLOURS

#### HUE

MATERIALS: 70% VISCOSE, 30% LINEN  
DURABILITY: 36.000 MARTINDALE  
AVAILABLE IN ALL COLOURS

#### LINARA

MATERIALS: 63% COTTON, 37% LINEN  
DURABILITY: 36.000 MARTINDALE  
COLOURS: 6

#### MESSENGER

MATERIALS: 78% POST INDUSTRIAL RECYCLED,  
15% POLYESTER, 7% NYLON  
DURABILITY: 65.000 MARTINDALE  
AVAILABLE IN ALL COLOURS

#### MOOD

MATERIALS: 92% WOOL, 8% POLYAMID  
DURABILITY: 100.000 MARTINDALE  
AVAILABLE IN ALL COLOURS

#### REMIX

MATERIALS: 90% NEW WOOL (WORSTED) 10% NYLON  
DURABILITY: 100.000 MARTINDALE  
AVAILABLE IN ALL COLOURS

#### RIME

MATERIALS: 90% NEW WOOL (WORSTED), 10% NYLON  
DURABILITY: 100.000 MARTINDALE  
AVAILABLE IN ALL COLOURS

#### TONUS

MATERIALS: 90% NEW WOOL, 10% HELANCA  
DURABILITY: 100.000 MARTINDALE  
AVAILABLE IN ALL COLOURS

### CATEGORY 2

#### DIVINA

MATERIALS: 100% NEW WOOL  
DURABILITY: 45.000 MARTINDALE  
AVAILABLE IN ALL COLOURS

#### DIVINA MD

MATERIALS: 100% NEW WOOL  
DURABILITY: 45.000 MARTINDALE  
AVAILABLE IN ALL COLOURS

#### DIVINA MELANGE

MATERIALS: 100% NEW WOOL  
DURABILITY: 45.000 MARTINDALE  
AVAILABLE IN ALL COLOURS

#### FIORD

MATERIALS: 92% NEW WOOL (WORSTED), 8% NYLON  
DURABILITY: 60.000 MARTINDALE  
AVAILABLE IN ALL COLOURS

#### HALLINGDAL

MATERIALS: 70% NEW WOOL, 30% VISCOSE  
DURABILITY: 100.000 MARTINDALE  
AVAILABLE IN ALL COLOURS

#### HARALD (VELVET)

MATERIALS: 100% COTTON  
DURABILITY: 100.000 MARTINDALE  
AVAILABLE IN ALL COLOURS

#### KARAKORUM

MATERIALS: 42% WOOL, 33% VISCOSE, 24% COTTON,  
1% POLYAMIDE  
DURABILITY: 40.000 MARTINDALE  
AVAILABLE IN ALL COLOURS

#### MERIT

MATERIALS: 76% POST CONSUMER RECYCLED,  
24% POLYESTER  
DURABILITY: 85.000 MARTINDALE  
AVAILABLE IN ALL COLOURS

#### NABIS

MATERIALS: 48% COTTON, 30% VISCOSE,  
22% POLYESTER  
DURABILITY: 40.000 MARTINDALE  
COLOURS: 2

#### RAAS

MATERIALS: 92% NEW WOOL (WORSTED), 8% NYLON  
DURABILITY: 100.000 MARTINDALE  
AVAILABLE IN ALL COLOURS

#### RE-WOOL

MATERIALS: 45% RECYCLED WOOL, 45% NEW WOOL  
(WORSTED), 10% NYLON  
DURABILITY: 100.000 MARTINDALE  
AVAILABLE IN ALL COLOURS

#### SAFIRE

MATERIALS: 43% VISCOSE, 17% POLYACRYL,  
15% NEW WOOL, 9% COTTON, 8% LINEN, 8% POLYESTER  
DURABILITY: 40.000 MARTINDALE  
AVAILABLE IN ALL COLOURS

#### STEELCUT

MATERIALS: 90% NEW WOOL (WORSTED) 10% NYLON  
DURABILITY: 100.000 MARTINDALE  
AVAILABLE IN ALL COLOURS

#### STEELCUT TRIO

MATERIALS: 90% NEW WOOL (WORSTED) 10% NYLON  
DURABILITY: 100.000 MARTINDALE  
AVAILABLE IN ALL COLOURS

#### SUNNIVA

MATERIALS: 58% NEW WOOL, 25% VISCOSE, 8% LINEN,  
5% NYLON, 4% POLYESTER  
DURABILITY: 50.000 MARTINDALE  
AVAILABLE IN ALL COLOURS

#### TWILL WEAVE

MATERIALS: 90% NEW WOOL (WORSTED), 10% NYLON  
DURABILITY: 60.000 MARTINDALE  
AVAILABLE IN ALL COLOURS

#### VANIR

MATERIALS: 92% NEW WOOL (WORSTED), 8% NYLON  
DURABILITY: 100.000 MARTINDALE  
COLOURS: 12

#### VIDAR

MATERIALS: 94% NEW WOOL, 6% NYLON  
DURABILITY: 100.000 MARTINDALE  
AVAILABLE IN ALL COLOURS

### CATEGORY 3

#### COMFORT

MATERIALS: 88% POLYESTER, 12% NYLON  
DURABILITY: 150.000 MARTINDALE  
AVAILABLE IN ALL COLOURS

#### SONAR

MATERIALS: 59% NEW WOOL, 25% VISCOSE,  
9% LINEN, 5% NYLON, 2% POLYESTER  
DURABILITY: 20.000 MARTINDALE  
AVAILABLE IN ALL COLOURS

#### GENTLE (VELVET)

MATERIALS: 60% WOOL, 20% POLYAMIDE,  
20% POLYESTER  
DURABILITY: 90.000 MARTINDALE  
AVAILABLE IN ALL COLOURS

#### VIDAR

MATERIALS: 94% NEW WOOL, 6% NYLON  
DURABILITY: 100.000 MARTINDALE  
AVAILABLE IN ALL COLOURS

### CATEGORY 4

#### ATOM

MATERIALS: 90% NEW WOOL (WORSTED),  
8% NYLON, 2% POLYESTER  
DURABILITY: 65.000 MARTINDALE  
COLOURS: 2

#### RIA

MATERIALS: 84% NEW WOOL (WORSTED),  
12% VISCOSE, 4% NYLON  
DURABILITY: 50.000 MARTINDALE  
AVAILABLE IN ALL COLOURS

### MISCELLANEOUS

#### JUST

MATERIALS: 98% POST-CONSUMER RECYCLED  
POLYESTER / 2% POLYESTER  
DURABILITY: 70.000 MARTINDALE

#### SALSA

MATERIALS: 100% POLYESTER  
DURABILITY: 200.000 MARTINDALE



# SURFACE SELECTION

Colours and materials may vary from the images shown.

## TEXTILES

### CHRISTIANSHAVN™



BLACK UNI  
1175

DARK GREY  
1174

GREY  
1173

GREY UNI  
1172

LIGHT GREY  
1171

LIGHT GREY UNI  
1170

ORANGE/BLUE  
1150

LIGHT BLUE  
1152

LIGHT BLUE UNI  
1151

BLUE UNI  
1153

BLUE  
1154

DARK BLUE  
1155

DARK GREEN  
1161

DARK GREEN UNI  
1160

DARK RED UNI  
1142

RED  
1141

RED UNI  
1140

BLUE/ORANGE  
1135

DARK ORANGE  
1134

ORANGE  
1133

BEIGE/ORANGE  
1132

ORANGE/RED  
1131

LIGHT RED UNI  
1130

BEIGE  
1121

LIGHT BEIGE  
1120

YELLOW  
1110

Alphabet™ Sofa  
Ant™  
Drop™  
Egg™  
Favn™  
Fred™  
Fri™  
Grand Prix™  
Let™  
Lily™  
Lissoni Sofa™  
Little Giraffe™  
Lune™  
Oxford™  
Plenum™  
Pot™  
Ro™  
Ro™ Sofa  
Series 7™  
Series 3300™  
Swan™  
Swan Sofa™  
VIA57™  
Vico Duo™

MATERIALS: 85% WOOL, 15% POLYAMID  
DURABILITY: 200.000 MARTINDALE  
LIGHT FASTNESS: 5-7  
COLOURS: 26

Christianshavn™ is a timeless, wool mix textile designed by Fritz Hansen. Its 26 contemporary colours offer an immense variety in both unicolour and melange weave. It has superior comfort due to the wool mix and with its high durability and a 200.000 rubs martindale, it is suitable for all upholstered products in the Fritz Hansen collection. The name; Christianshavn leads back to where it all started. The young enterprising cabinet-maker Fritz Hansen started his furniture production company in Christianshavn - a central part of Copenhagen. Christianshavn can be used in private interiors as well as public areas.

## DESIGNER SELECTION COLOURS

### FRI™

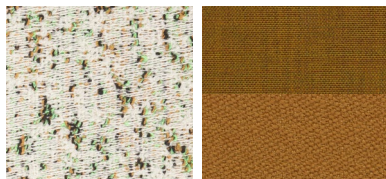

ATOM WHITE  
Shell: Atom 0124  
Cushions: Atom 0124

BURNT YELLOW  
Shell: Remix 422  
Cushions: Vidar 472

### RO™

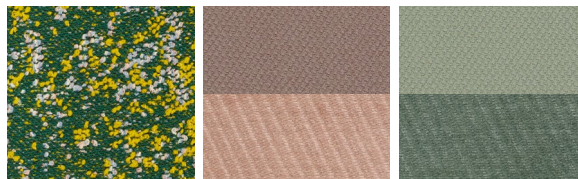

ATOM GREEN  
Shell: Atom 0964  
Cushions: Atom 0964

PALE ROSE  
Shell: Steelcut 605  
Cushions: Nabis 0011

MINT GREEN  
Shell: Steelcut 935  
Cushions: Nabis 0023

# SURFACE SELECTION

Colours and materials may vary from the images shown.

## SELECTED TEXTILE COLOURS

### BELFAST (VELVET)



**FOREST GREEN**  
770660  
Ant™  
Fred™  
Series 7™  
Vico Duo™

**MISTY ROSE**  
770593  
Ant™  
Fred™  
Series 7™  
Vico Duo™

**NIGHT BLACK**  
772150  
Ant™  
Fred™  
Series 7™  
Vico Duo™

**DARK PLUM**  
774232  
Ant™  
Fred™  
Series 7™  
Vico Duo™

**SEAL GREY**  
775139  
Ant™  
Fred™  
Series 7™  
Vico Duo™

**SOFT OCHRE**  
774926  
Ant™  
Fred™  
Series 7™  
Vico Duo™

**GREY BROWN**  
771772  
Ant™  
Fred™  
Series 7™  
Vico Duo™



**AUTUMN RED**  
772255  
Ant™  
Fred™  
Series 7™  
Vico Duo™

**GREY BLUE**  
772143  
Ant™  
Fred™  
Series 7™  
Vico Duo™

**MIDNIGHT BLUE**  
772062  
Ant™  
Fred™  
Series 7™  
Vico Duo™

### LINARA



**BLUEBERRY**  
2494/198  
Lune™

**EUCALYPTUS**  
2494/324  
Lune™

**GINGERSNAP**  
2494/118  
Lune™

**GREY MIST**  
2494/340  
Lune™

**INDIGO**  
2494/30  
Lune™

**LEAD**  
2494/237  
Lune™

### VANIR



**BLACK**  
193  
Ant™  
Grand Prix™  
Lily™  
Series 7™

**BEIGE BLUE**  
243  
Ant™  
Grand Prix™  
Lily™  
Series 7™

**GRANITE BROWN**  
373  
Ant™  
Grand Prix™  
Lily™  
Series 7™

**BLACK BROWN**  
393  
Ant™  
Grand Prix™  
Lily™  
Series 7™

**WHITE OCHRE**  
413  
Ant™  
Grand Prix™  
Lily™  
Series 7™

**BURNT OCHRE**  
443  
Ant™  
Grand Prix™  
Lily™  
Series 7™

**YELLOW PLUM**  
473  
Ant™  
Grand Prix™  
Lily™  
Series 7™



**MIDNIGHT BLUE**  
693  
Ant™  
Grand Prix™  
Lily™  
Series 7™

**LIGHT BLUE**  
733  
Ant™  
Grand Prix™  
Lily™  
Series 7™

**GREY BLUE**  
773  
Ant™  
Grand Prix™  
Lily™  
Series 7™

**BRIGHT GREEN**  
913  
Ant™  
Grand Prix™  
Lily™  
Series 7™

**DARK GREEN**  
983  
Ant™  
Grand Prix™  
Lily™  
Series 7™

# SURFACE SELECTION

## LEATHER

Please note that leather is a natural material with natural variation in colour and surface structure. The presence of scars and marks from bites etc. on the leather may occur and are characteristics of genuine leather.

Further information about materials, care and maintenance can be found on [www.fritzhanzen.com](http://www.fritzhanzen.com).

### CUSTOMER'S OWN LEATHER (COL)

Customers can supply their own leather. Prices excluding leather as well as leather requirements can be given on inquiry. Please note that only very few types of leather/qualities are suitable. Fritz Hansen retains the right to reject the qualities we find unsuitable.

### SPECIAL LEATHER COLOURS

On inquiry and at a surcharge, special leather colours may be available for the models available with leather upholstery.

	AURA	BUFFED	EMBRACE	ESSENTIAL	GRACE	INTENSE	NATURAL	RAW	RUSTIK	SOFT	WILD
ANT™ FRONT			•	•	•		•			•	
CHINA CHAIR™	•		•		•		•		•		
DOT™		•				•					•
DROP™	•		•	•	•		•		•		
EGG™	•		•	•	•		•		•		
FRED™				•							
GRAND PRIX™ FRONT			•	•	•		•			•	
GRAND PRIX™ FULL			•	•	•		•		•	•	
HIGH DOT™		•				•					•
LET™				•							
LILY™			•	•	•		•		•	•	
LITTLE GIRAFFE™	•		•	•	•		•		•		
LISSONI SOFA™			•	•	•		•		•	•	
LUNE™	•		•							•	
NO1™ SEAT CUSHION								•			
OKSEN™	•			•	•						
OXFORD™			•	•	•		•		•	•	
POT™	•		•	•	•		•		•		
SERIES 7™ FRONT			•	•	•		•			•	
SERIES 7™ FULL			•	•	•		•		•	•	
SERIES 7™ SEAT CUSHION						•		•			•
SERIES 3300™	•		•	•	•		•		•		
SWAN™	•		•	•	•		•		•		
SWAN SOFA™	•		•	•	•		•		•		
VICO DUO™ FRONT			•	•	•		•			•	
VICO DUO™ FULL			•	•	•		•		•	•	

# SURFACE SELECTION

Colours and materials may vary from the images shown.

## LEATHER

### AURA



BLACK

BLACK BROWN

COGNAC

WALNUT

China Chair™  
Drop™  
Egg™  
Little Giraffe™  
Lune™  
Oksen™  
Pot™  
Series 3300™  
Swan™  
Swan Sofa™

**CATEGORY: 4**  
CHROME-TANNED, TOP-COATED, STRONG FULL-GRAIN  
AND DURABLE SURFACE.  
THICKNESS 1.4-1.6 MM.

### EMBRACE

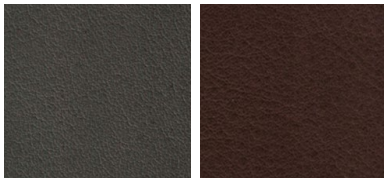

CONCRETE GREY

CHOCOLATE

Ant™  
China Chair™  
Drop™  
Egg™  
Grand Prix™  
Lily™  
Little Giraffe™  
Lissoni Sofa™  
Lune™  
Oxford™  
Pot™  
Series 7™  
Series 3300™  
Swan™  
Swan Sofa™  
Vico Duo™

**CATEGORY: 5**  
CHROME-TANNED, FULLY GRAINED, EXTRAORDINARY SOFT ANILINE  
WITH A SPECIAL WAXING GIVING A SLIGHTLY 'OILY' SURFACE. COLOUR  
VARIATIONS, VISIBLE NATURAL MARKINGS E.G. NECK WRINKLES.  
THICKNESS 1.2-1.4 MM.

### ESSENTIAL

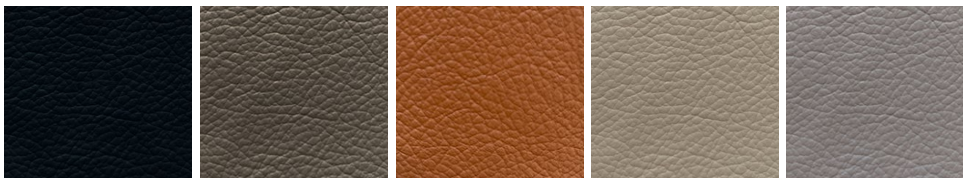

BLACK

STONE

WALNUT

LIGHT GREY

LAVA

Ant™  
Drop™  
Egg™  
Fred™  
Grand Prix™  
Let™  
Lily™  
Little Giraffe™  
Lissoni Sofa™  
Oksen™  
Oxford™  
Pot™  
Series 7™  
Series 3300™  
Swan™  
Swan Sofa™  
Vico Duo™

**CATEGORY: 3**  
CHROME-TANNED, LIGHTLY POLISHED, TOP-COATED  
AND GRAIN PRINTED DURABLE SURFACE.  
THICKNESS 1.0-1.2 MM.



# SURFACE SELECTION

Colours and materials may vary from the images shown.

## LEATHER

### GRACE

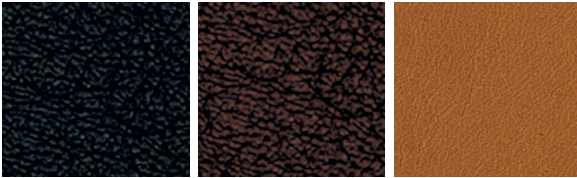

BLACK

DARK BROWN

WALNUT

Ant™  
China Chair™  
Drop™  
Egg™  
Grand Prix™  
Lily™  
Little Giraffe™  
Lissoni Sofa™  
Oksen™  
Oxford™  
Pot™  
Series 7™  
Series 3300™  
Swan™  
Swan Sofa™  
Vico Duo™

**CATEGORY: 5**  
VEGETABLE AND CHROME-TANNED, ANILINE, FULL-GRAIN WITH LIGHT STRUCTURE AND LIGHT IMPREGNATION. BECOMES LIGHTER AND PATINATED WITH USE, VISIBLE NATURAL MARKINGS.  
THICKNESS 1.2-1.4 MM.

### NATURAL



NATURAL

Ant™  
China Chair™  
Drop™  
Egg™  
Grand Prix™  
Lily™  
Little Giraffe™  
Lissoni Sofa™  
Oxford™  
Pot™  
Series 7™  
Series 3300™  
Swan™  
Swan Sofa™  
Vico Duo™

**CATEGORY: 5**  
VEGETABLE-TANNED, CHROME-FREE, NATURAL LEATHER, NO COLOUR OR PROTECTIVE FINISH. BECOMES DARKER AND PATINATED WITH USE, VISIBLE NATURAL MARKINGS.  
THICKNESS 1.2-1.4 MM.

### RUSTIK



RUSTIK

China Chair™  
Drop™  
Egg™  
Grand Prix™  
Lily™  
Little Giraffe™  
Lissoni Sofa™  
Oxford™  
Pot™  
Series 7™  
Series 3300™  
Swan™  
Swan Sofa™  
Vico Duo™

**CATEGORY: 5**  
VEGETABLE-TANNED, CHROME-FREE, ANILINE, NO PROTECTIVE FINISH, LIGHT IMPREGNATION, VISIBLE NATURAL MARKS. BECOMES LIGHTER AND PATINATED WITH USE.  
THICKNESS 1.2-1.4 MM.

### SOFT

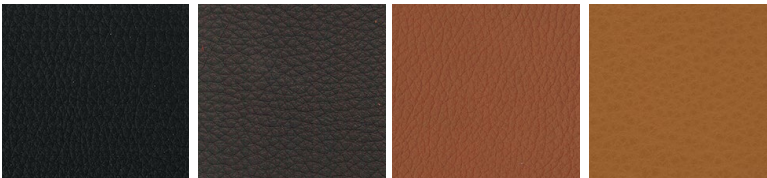

BLACK

BLACK BROWN

COGNAC

WALNUT

Ant™  
Grand Prix™  
Lily™  
Lissoni Sofa™  
Little Giraffe™  
Lune™  
Oxford™  
Series 7™  
Vico Duo™

**CATEGORY: 4**  
CHROME-TANNED, SEMI-ANILINE, FULL-GRAIN WITH LIGHT STRUCTURE AND SURFACE FINISH.  
THICKNESS 1.0-1.2 MM.

# SURFACE SELECTION

Colours and materials may vary from the images shown.

## SEAT CUSHIONS

### DROP™ (3110SC)



GREY  
TEXTILE  
SALSA 3/36

BLACK  
TEXTILE  
SALSA 3/39

### NAP™ (KS70)

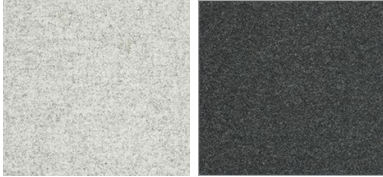

LIGHT GREY  
TEXTILE  
DIVINA MELANGE 120

DARK GREY  
TEXTILE  
DIVINA MELANGE 180

### NO1™ (N70/N71)

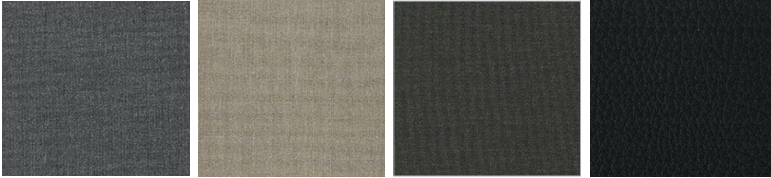

DARK BLUE/GREY  
TEXTILE  
REMIX 173

BEIGE  
TEXTILE  
REMIX 233

DARK BROWN  
TEXTILE  
REMIX 393

BLACK  
LEATHER  
RAW

### NO2™ RECYCLE (N02-70)



LIGHT GREY  
TEXTILE  
JUST 60118

DARK GREY  
TEXTILE  
JUST 60121

BLACK  
TEXTILE  
JUST 60999

### SERIES 7™ (3107SC)

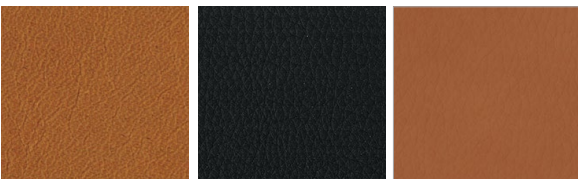

WALNUT  
LEATHER  
WILD

BLACK  
LEATHER  
RAW

BROWN  
LEATHER  
INTENSE

### VICO DUO™ (VM170)

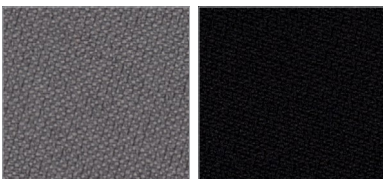

DARK GREY  
TEXTILE  
JUST 60121

BLACK  
TEXTILE  
JUST 60999

# SURFACE SELECTION

Colours and materials may vary from the images shown.

## NATURAL VENEER CHAIRS AND LOUNGE



MAPLE  
10  
Ant™  
Series 7™

BEECH  
20  
Ant™  
N01™  
Series 7™

ASH  
30  
Ant™  
Series 7™

CHERRY  
40  
Ant™  
Series 7™

OREGON PINE  
50  
Ant™  
Series 7™

ELM  
60  
Ant™  
Series 7™



OAK  
70  
Ant™  
Grand Prix™  
N01™  
NAP™  
Series 7™  
Series 7™ Junior  
Vico Duo™

WALNUT  
80  
Ant™  
Grand Prix™  
Lily™  
Series 7™  
Vico Duo™

DARK STAINED OAK  
90  
Ant™  
Series 7™

FULL DARK STAINED OAK  
90  
Ant™  
Series 7™

## NATURAL VENEER TABLES



ASH  
31  
Stub™

OAK  
71  
Little Friend™

OAK  
72  
Pluralis™  
Stub™

OAK  
74  
Analog™

WALNUT  
80  
Circular  
Egg™ Table  
FH3605™  
Rectangular  
Supercircular™  
Superellipse™

WALNUT  
81  
Little Friend™

WALNUT  
82  
Pluralis™



WALNUT  
84  
Analog™

## NATURAL VENEER SHELVING

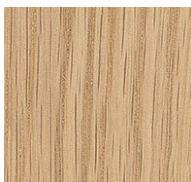

OAK  
73  
Planner™ Shelving

# SURFACE SELECTION

Colours and materials may vary from the images shown.

## COLOURED ASH CHAIRS AND LOUNGE

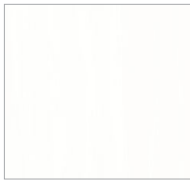

**WHITE**  
105  
Ant™  
Grand Prix™  
Series 7™



**LIGHT BEIGE**  
135  
Ant™  
Grand Prix™  
Series 7™



**DEEP CLAY**  
145  
Ant™  
Grand Prix™  
Series 7™



**NINE GREY**  
155  
Ant™  
Grand Prix™  
Series 7™



**BLACK**  
195  
Ant™  
Grand Prix™  
Series 7™  
Series 7™ Children's Chair  
Series 7™ Junior  
Vico Duo™



**TRUE YELLOW**  
465  
Ant™  
Grand Prix™  
Series 7™



**BURNT YELLOW**  
475  
Ant™  
Grand Prix™  
Series 7™  
Series 7™ Junior



**PARADISE ORANGE**  
575  
Ant™  
Grand Prix™  
Series 7™



**PALE ROSE**  
615  
Ant™  
Grand Prix™  
Series 7™



**ROSE**  
626  
Series 7™ Children's Chair

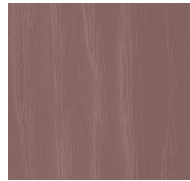

**WILD ROSE**  
635  
Ant™  
Grand Prix™  
Series 7™



**VENETIAN RED**  
675  
Ant™  
Grand Prix™  
Series 7™

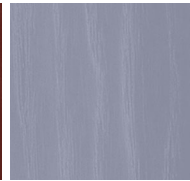

**LAVENDER BLUE**  
815  
Ant™  
Grand Prix™  
Series 7™  
Series 7™ Children's Chair

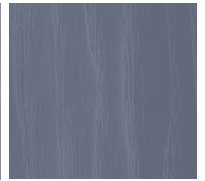

**DUSK BLUE**  
855  
Ant™  
Grand Prix™  
Series 7™



**MIDNIGHT BLUE**  
895  
Ant™  
Grand Prix™  
Series 7™

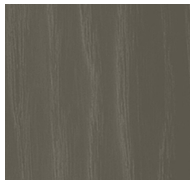

**OLIVE GREEN**  
925  
Ant™  
Grand Prix™  
Series 7™



**EVERGREEN**  
955  
Ant™  
Grand Prix™  
Series 7™  
Series 7™ Junior

## COLOURED ASH TABLES



**BLACK**  
193  
Stub™



**BLACK**  
195  
AJ Trolley™  
FH3605™

# SURFACE SELECTION

Colours and materials may vary from the images shown.

## COLOURED OAK CHAIRS



BLACK  
196  
N01™

## LACQUERED CHAIRS

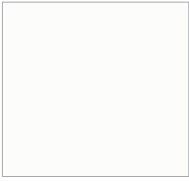

WHITE  
100  
Ant™  
Grand Prix™  
Series 7™



LIGHT BEIGE  
130  
Ant™  
Grand Prix™  
Series 7™



DEEP CLAY  
140  
Ant™  
Grand Prix™  
Series 7™



NINE GREY  
150  
Ant™  
Grand Prix™  
Series 7™



BLACK  
190  
Ant™  
Grand Prix™  
Series 7™



TRUE YELLOW  
460  
Ant™  
Grand Prix™  
Series 7™



BURNT YELLOW  
470  
Ant™  
Grand Prix™  
Series 7™



PARADISE ORANGE  
570  
Ant™  
Grand Prix™  
Series 7™



PALE ROSE  
610  
Ant™  
Grand Prix™  
Series 7™



WILD ROSE  
630  
Ant™  
Grand Prix™  
Series 7™



VENETIAN RED  
670  
Ant™  
Grand Prix™  
Series 7™



LAVENDER BLUE  
810  
Ant™  
Grand Prix™  
Series 7™



DUSK BLUE  
850  
Ant™  
Grand Prix™  
Series 7™



MIDNIGHT BLUE  
890  
Ant™  
Grand Prix™  
Series 7™

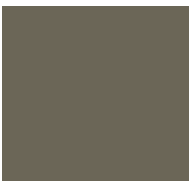

OLIVE GREEN  
920  
Ant™  
Grand Prix™  
Series 7™

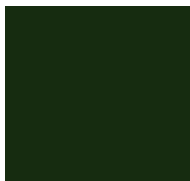

EVERGREEN  
950  
Ant™  
Grand Prix™  
Series 7™

# SURFACE SELECTION

Colours and materials may vary from the images shown.

## SOLID WOOD CHAIRS



## SOLID WOOD LOUNGE AND SOFAS

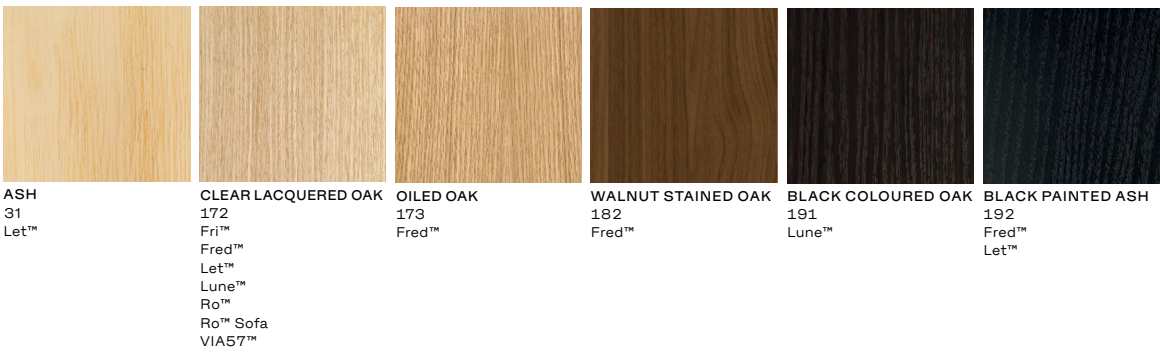

## SOLID WOOD TABLES

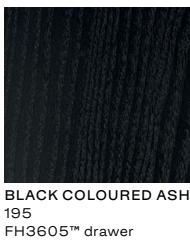

# SURFACE SELECTION

Colours and materials may vary from the images shown.

## PLASTIC CHAIRS

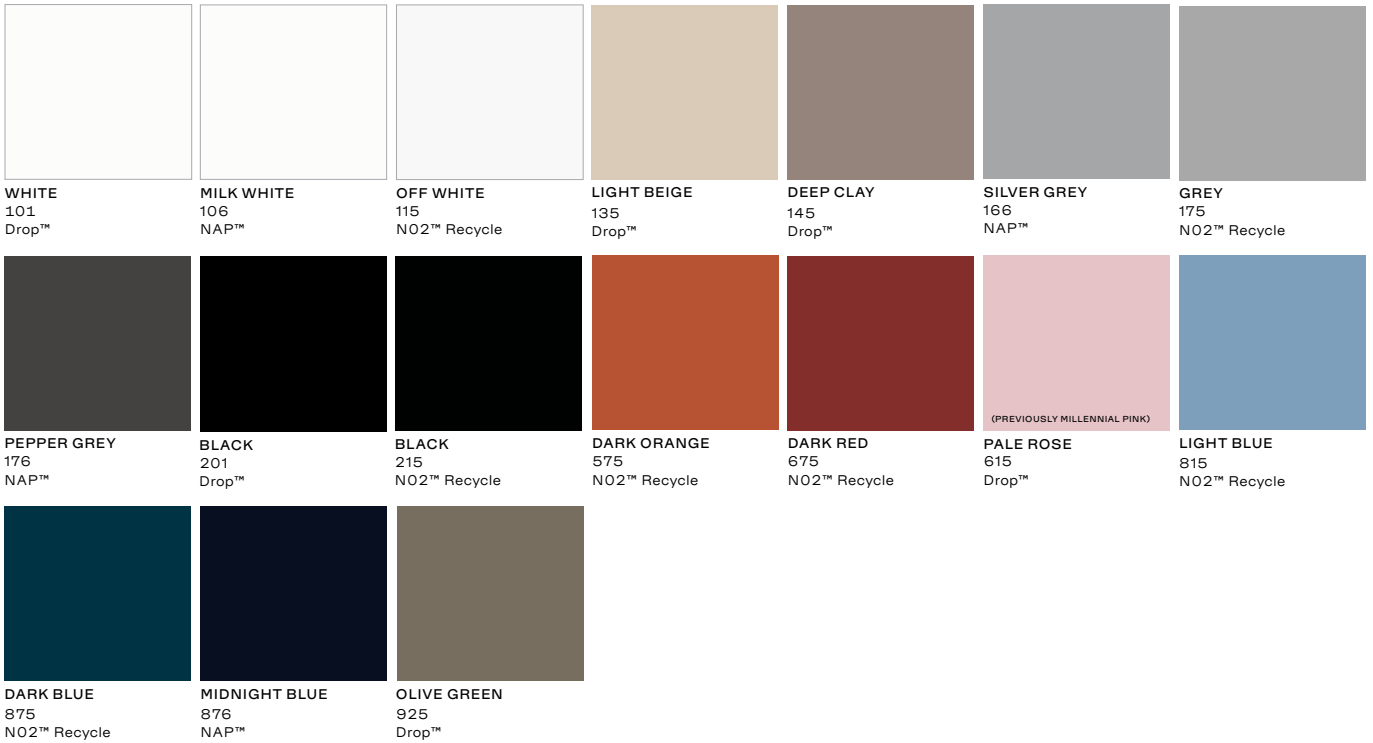

# SURFACE SELECTION

Colours and materials may vary from the images shown.

## LAMINATE TABLES

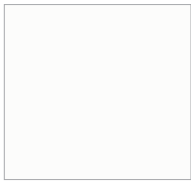

**WHITE**  
032  
Circular  
Rectangular  
Supercircular™  
Superellipse™

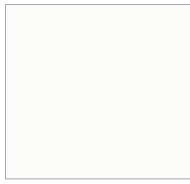

**WHITE**  
102  
Little Friend™

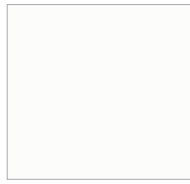

**WHITE**  
122  
Pluralis™

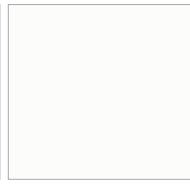

**WHITE**  
124  
Analog™



**BROWN OTTAWA**  
717  
Circular  
Rectangular  
Supercircular™  
Superellipse™



**GREY**  
718  
Circular  
Rectangular  
Supercircular™  
Superellipse™



**GREY BROMO**  
724  
Circular  
Rectangular  
Supercircular™  
Superellipse™



**GREY EFESO**  
725  
Circular  
Rectangular  
Supercircular™  
Superellipse™



**LIGHT GREY**  
Plenum™



**LAVA GREY**  
152  
Pluralis™



**BLACK**  
720  
Circular  
Essay™ extension leaf  
Rectangular  
Supercircular™  
Superellipse™



**BLACK**  
202  
Little Friend™

## LINOLEUM TABLES



**MAIVE BROWN**  
361  
Pluralis™

## MARBLE TABLES

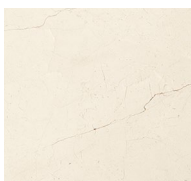

**CREAM**  
120  
Planner™ Table Series

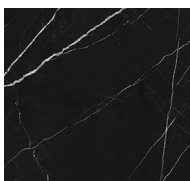

**CHARCOAL**  
220  
Planner™ Table Series

## GLASS TABLES

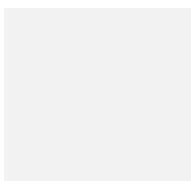

**CLEAR**  
100  
Stub™



# SURFACE SELECTION

Colours and materials may vary from the images shown.

## POWDER COATED/LACQUERED METAL CHAIRS



**WHITE**  
100  
Ant™  
Drop™  
Grand Prix™  
Series 7™

**MILK WHITE**  
106  
NAP™

**OFF WHITE**  
115  
NO2™ Recycle

**NINE GREY**  
150  
Ant™  
Grand Prix™  
Series 7™

**GREY**  
175  
NO2™ Recycle

**SILVER GREY**  
166  
NAP™

**SILVER GREY**  
170  
Ant™  
Grand Prix™  
Series 7™



**PEPPER GREY**  
176  
NAP™

**WARM GRAPHITE**  
180  
Ant™  
Drop™  
Grand Prix™  
Oxford™  
Series 7™

**BLACK**  
9005  
Dot™  
High Dot™

**BLACK**  
190  
Ant™  
Drop™  
Grand Prix™  
Little Giraffe™  
Oxford™  
Series 7™  
Vico Duo™

**BLACK**  
215  
NO2™ Recycle

**BROWN BRONZE**  
390  
Ant™  
Drop™  
Grand Prix™  
Oxford™  
Series 7™  
Series 7™ Junior



**ORANGE**  
556/575  
NO2™ Recycle

**DARK RED**  
675  
NO2™ Recycle

**LIGHT BLUE**  
815  
NO2™ Recycle



**DARK BLUE**  
875  
NO2™ Recycle

**MIDNIGHT BLUE**  
876  
NAP™

## POWDER COATED/LACQUERED METAL LOUNGE AND SOFAS

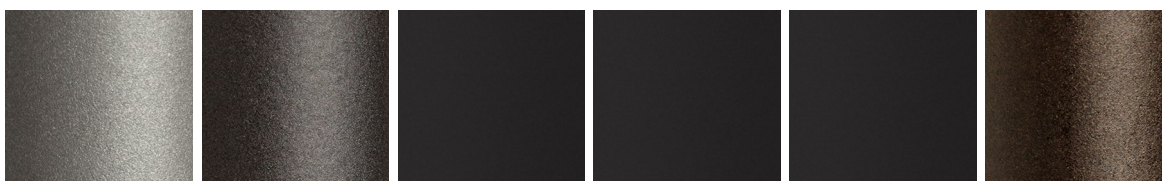

**SILVER GREY**  
170  
Egg™  
Swan™

**WARM GRAPHITE**  
180  
Egg™  
Let™  
Lissoni Sofa™  
Swan™

**BLACK**  
190  
Egg™  
Let™  
Lissoni Sofa™  
Swan™

**BLACK**  
252  
Plenum™

**BLACK**  
260  
Oksen™

**BROWN BRONZE**  
390  
Egg™  
Let™  
Lissoni Sofa™  
Pot™  
Swan™

# SURFACE SELECTION

Colours and materials may vary from the images shown.

## POWDER COATED/LACQUERED METAL TABLES



**WHITE**  
100  
Rectangular  
Supercircular™  
Superellipse™  
(only span legs)



**WHITE**  
102  
Little Friend™



**NINE GREY**  
150  
Rectangular  
Supercircular™  
Superellipse™  
(only span legs)

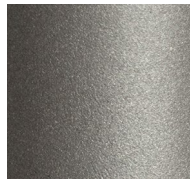

**SILVER GREY**  
170  
Circular  
Rectangular  
Supercircular™  
Superellipse™



**WARM GRAPHITE**  
180  
Circular  
Pluralis™  
Rectangular  
Supercircular™  
Superellipse™



**BLACK**  
190  
Circular  
FH3605™  
Pluralis™  
Rectangular  
Supercircular™  
Superellipse™



**BLACK**  
202  
Little Friend™

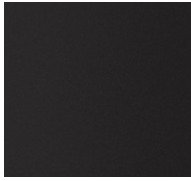

**BLACK**  
250  
Planner™ Table Series



**BLACK**  
251  
Join™

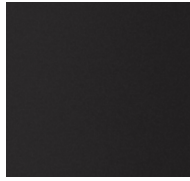

**BLACK**  
252  
Plenum™



**BROWN BRONZE**  
390  
Circular  
Pluralis™  
Rectangular  
Supercircular™  
Superellipse™

## POWDER COATED/LACQUERED METAL SHELVING AND OTHER

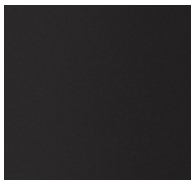

**BLACK**  
250  
Planner™ Shelving



**DARK BLUE**  
5008  
Coat Tree™ Wall



**LIGHT GREY**  
7047  
Coat Tree™ Wall